

<p>Ligg</p>	<p>1: 10.1 ↗ 2: 9.3 → 3: *10.5 ↗ 4: 8.8 ↗ 5: 10.3 ↗</p> <p>Serie 47.0 Total 47.0</p>	<p>Stå</p>	<p>1: 10.2 ↘ 2: 10.3 ↙ 3: *10.9 ↙ 4: 9.6 ↗ 5: 10.3 ←</p> <p>Serie 49.0 Total 96.0</p>
-------------	--	------------	---

<p>Kne</p>	<p>1: 9.5 → 2: 10.0 ↗ 3: 10.3 ↙ 4: *10.7 → 5: 9.3 ←</p> <p>Serie 48.0 Total 144.0</p>	<p>Grunnlag</p>	<p>1: 10.3 ↗ 2: 9.5 ↘ 3: 9.4 ↗ 4: 9.2 → 5: 9.4 ↘ 6: 9.9 ↘ 7: 10.0 → 8: 9.8 ↗ 9: *10.6 → 10: *10.7 ↙</p> <p>Serie 94.0 Total 238.0</p>
------------	---	-----------------	---

<p>Omgang</p>	<p>1: 9.1 ↓ 2: 10.2 ↓ 3: 7.6 ↓ 4: 9.1 ↘ 5: 9.3 ←</p> <p>Serie 44.0 Total 282.0</p>	
---------------	--	--

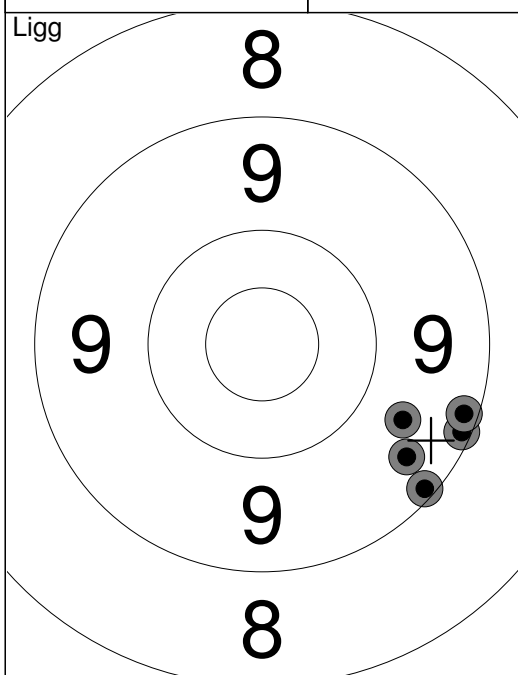

1:	9.4	↘
2:	9.1	↘
3:	9.1	↘
4:	9.2	↘
5:	9.6	↘
Serie		45.0
Total		45.0

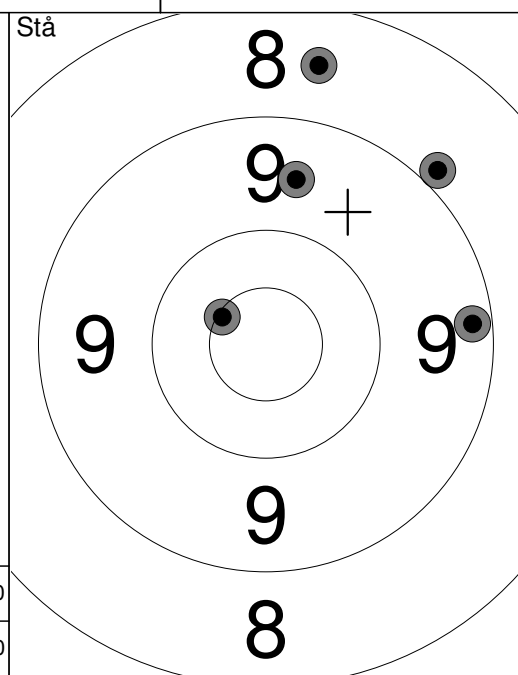

1:	8.9	↗
2:	*10.6	↖
3:	9.2	→
4:	9.6	↑
5:	8.5	↑
Serie		44.0
Total		89.0

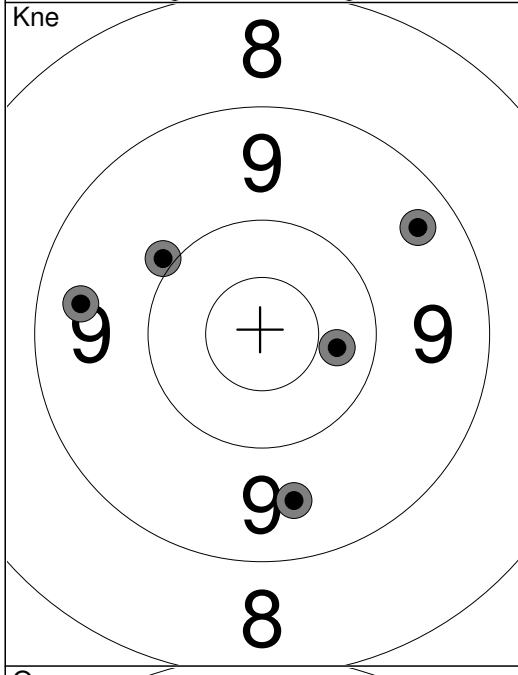

1:	10.4	→
2:	9.5	↘
3:	9.9	↗
4:	9.4	↗
5:	9.4	↖
Serie		46.0
Total		135.0

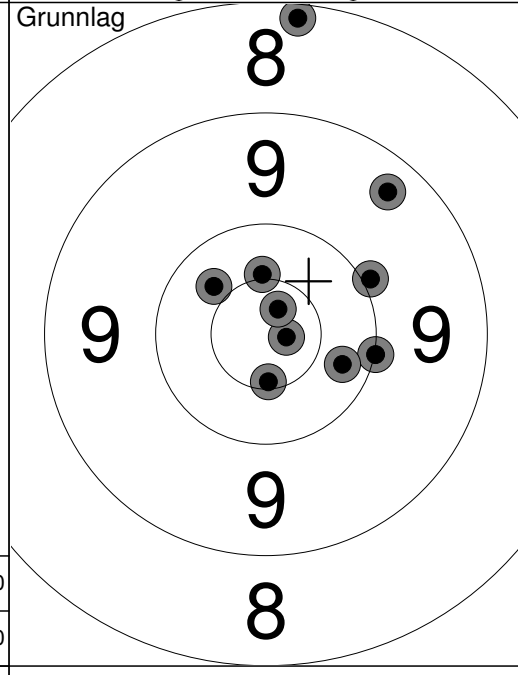

1:	8.2	↑
2:	10.0	→
3:	9.3	↗
4:	10.3	→
5:	10.0	↗
6:	10.4	↖
7:	*10.8	→
8:	*10.8	↗
9:	*10.6	↘
10:	*10.5	↑
Serie		97.0
Total		232.0

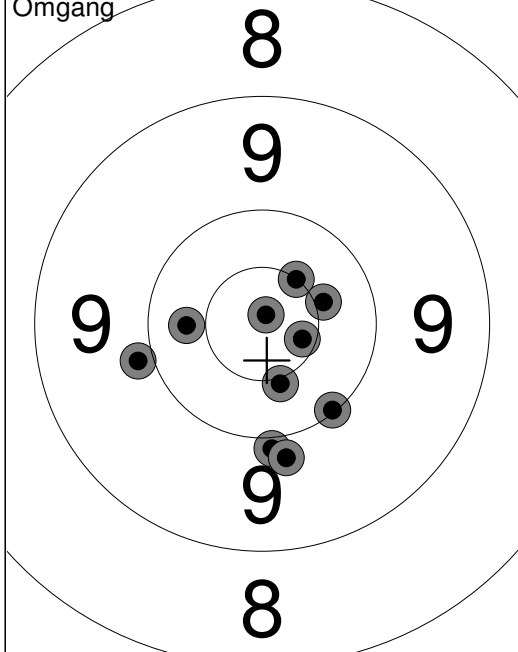

1:	*10.5	↘
2:	*10.9	↗
3:	*10.5	↗
4:	9.9	↘
5:	10.1	↘
6:	*10.7	→
7:	*10.5	→
8:	9.8	↘
9:	9.9	↖
10:	10.4	↖
Serie		97.0
Total		329.0

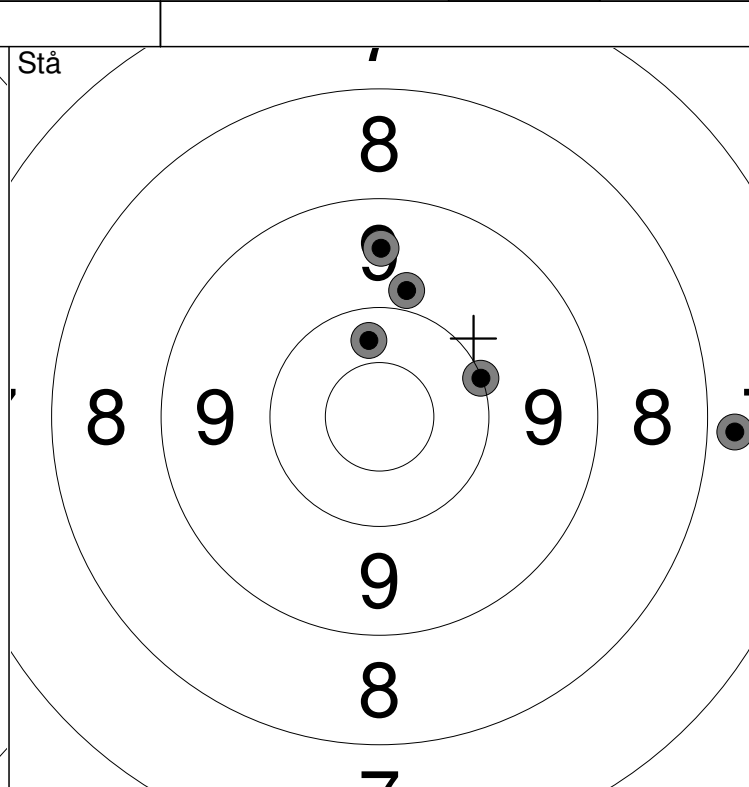
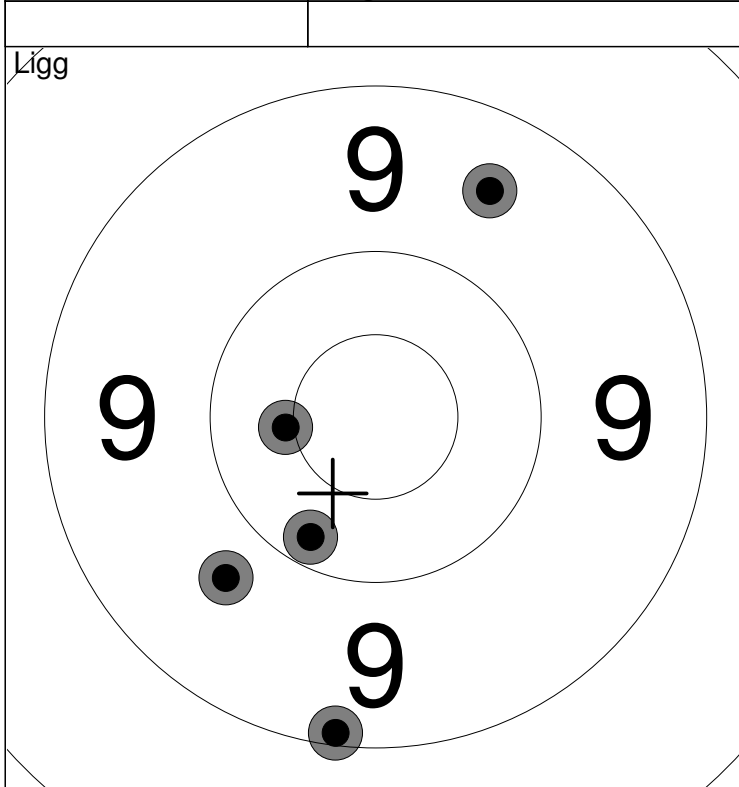

1: 9.7 ↙	Serie	47.0
2: 10.2 ↘		
3: 9.5 ↗	Total	47.0
4: *10.5 ←		
5: 9.1 ↓		

1: 9.5 ↑	Serie	45.0
2: 10.0 →		
3: 10.3 ↑	Total	92.0
4: 9.9 ↑		
5: 7.8 →		

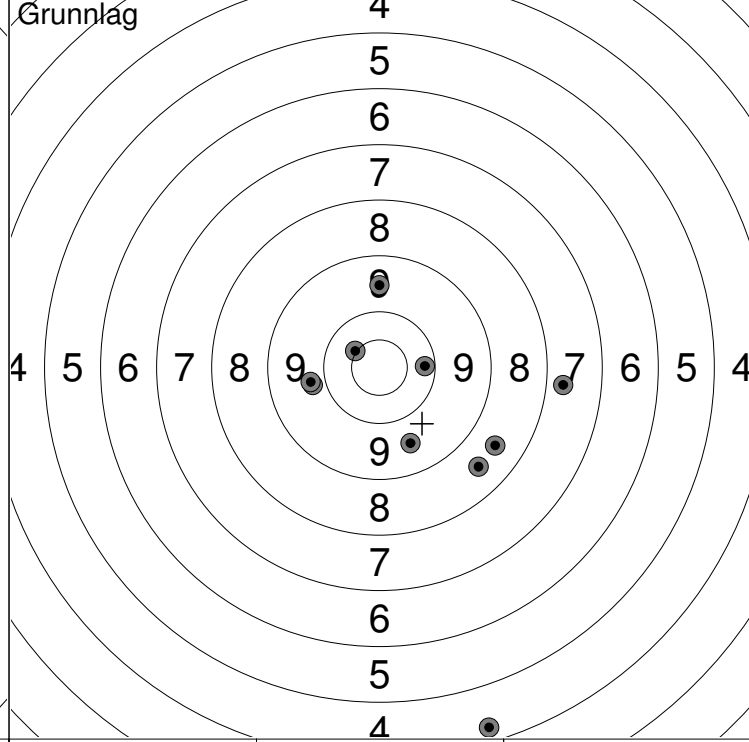
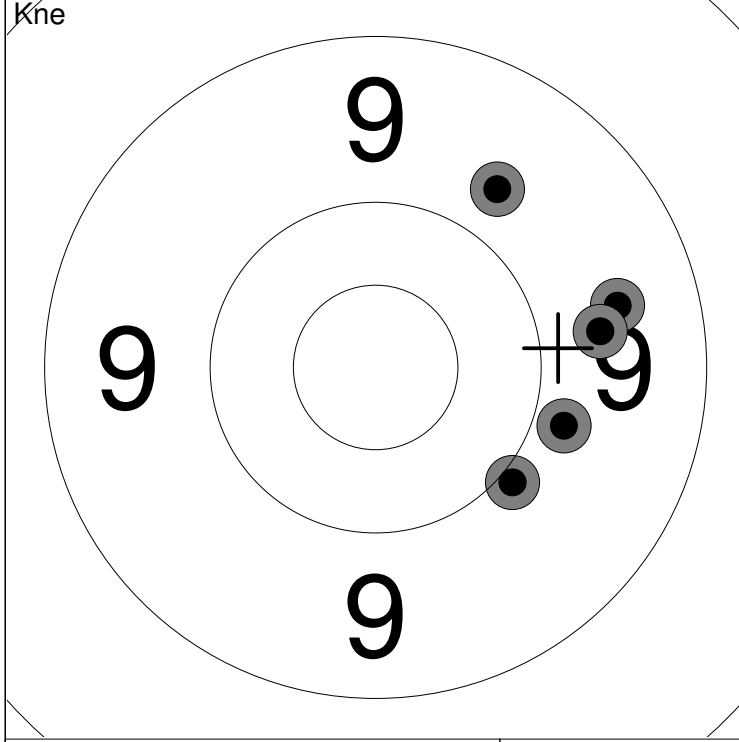

1: 9.7 ↗	Serie	45.0
2: 9.9 ↘		
3: 9.5 →	Total	137.0
4: 9.7 →		
5: 9.8 ↘		

1: 9.6 ↘	Serie	83.0
2: 4.3 ↘		
3: 7.7 →	Total	220.0
4: 8.5 ↘		
5: 10.2 →		
6: 8.5 ↘		
7: 9.8 ←		
8: 9.8 ←		
9: 9.6 ↑		
10: *10.5 ↙		

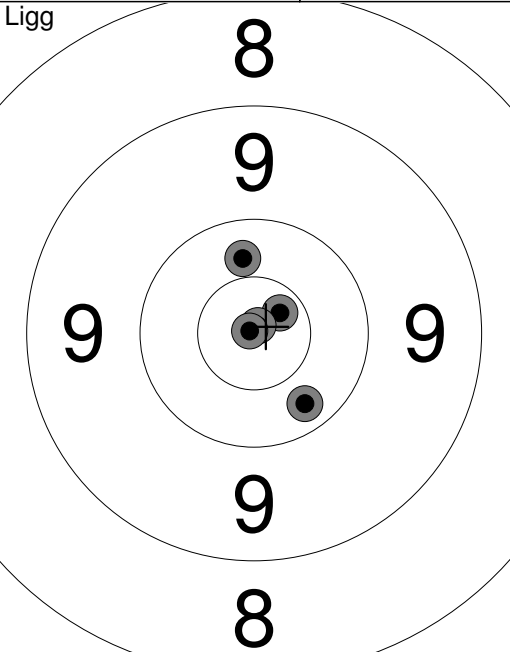
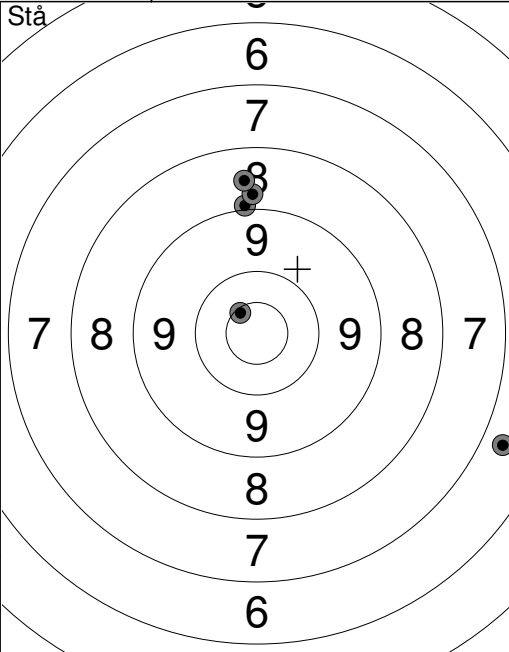
<p>Ligg</p> 	<p>1: *10.7 ↗ 2: 10.4 ↑ 3: *10.9 ↗ 4: 10.3 ↓ 5: *10.9 ↖</p>	<p>Stå</p> 	<p>1: *10.6 ↖ 2: 6.7 → 3: 9.0 ↑ 4: 8.8 ↑ 5: 8.6 ↑</p>
Serie 50.0		Serie 41.0	
Total 50.0		Total 91.0	

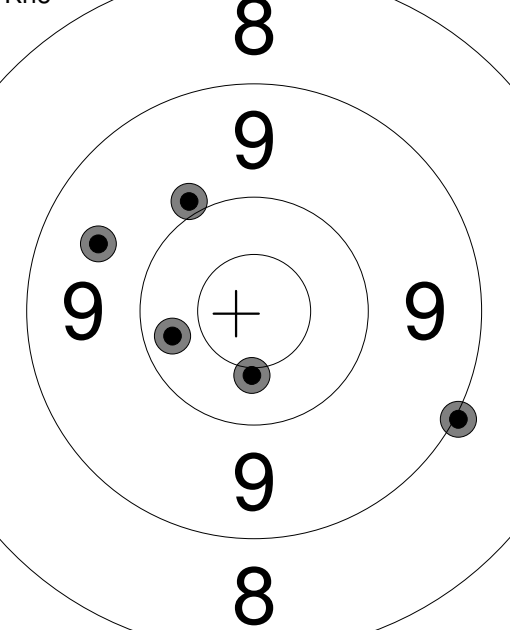
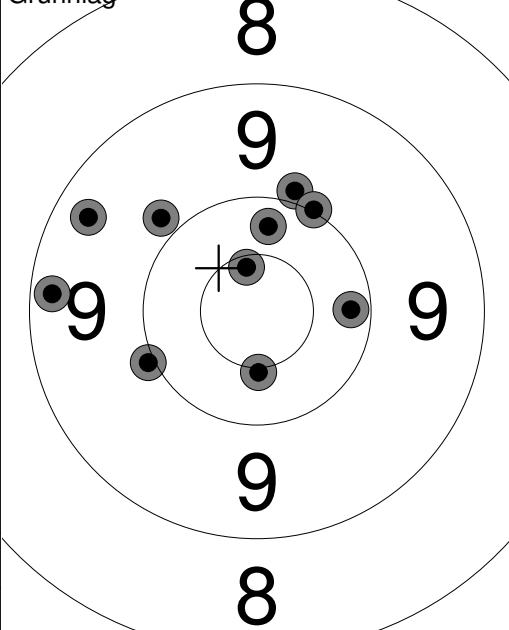
<p>Kne</p> 	<p>1: 9.5 ↖ 2: 10.3 ← 3: *10.5 ↓ 4: 9.0 → 5: 9.9 ↗</p>	<p>Grunnlag</p> 	<p>1: 10.3 ↑ 2: 9.9 ↖ 3: 9.3 ↖ 4: *10.5 ↓ 5: 9.2 ← 6: 10.2 → 7: 9.9 ↑ 8: *10.6 ↑ 9: 10.0 ↖ 10: 10.0 ↗</p>
Serie 47.0		Serie 96.0	
Total 138.0		Total 234.0	

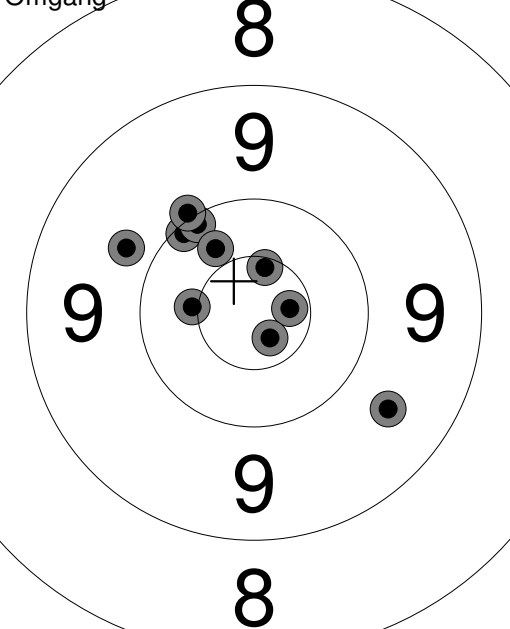
<p>Omgang</p> 	<p>1: 10.1 ↗ 2: 10.1 ↗ 3: *10.7 → 4: *10.5 ← 5: 10.4 ↗ 6: 9.8 ↗ 7: 10.0 ↗ 8: *10.6 ↑ 9: 9.6 ↓ 10: *10.8 ↓</p>		
Serie 98.0			
Total 332.0			

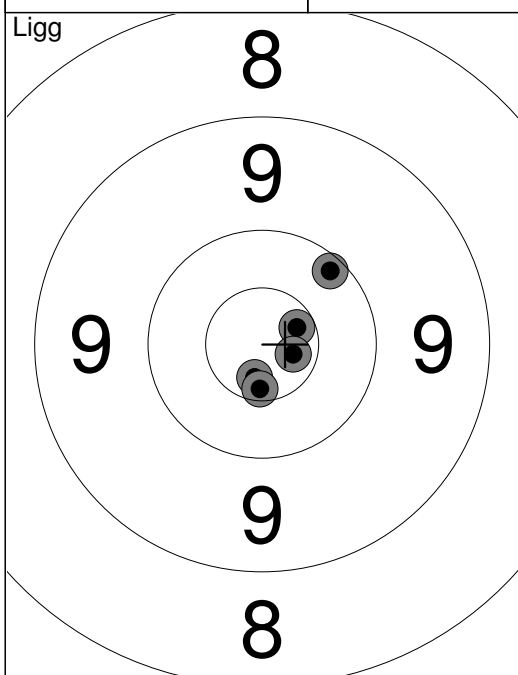

1:	*10.7	↗
2:	*10.7	↓
3:	*10.7	↗
4:	10.2	↗
5:	*10.6	↓
Serie		50.0
Total		50.0

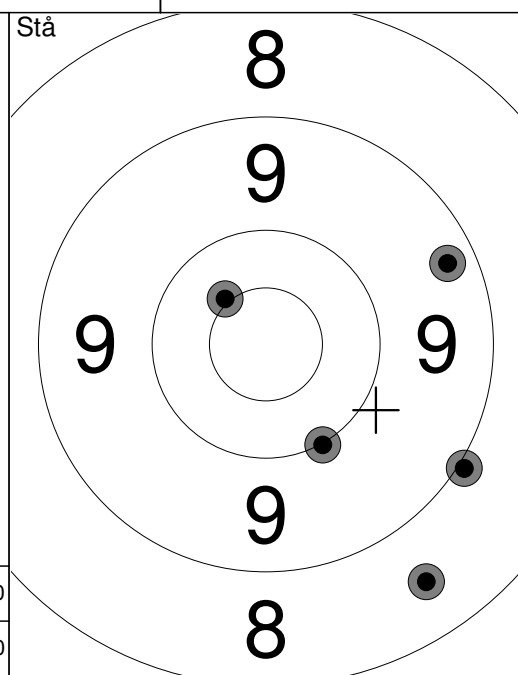

1:	10.0	↓
2:	9.3	↗
3:	8.5	↓
4:	*10.5	↗
5:	9.0	↓
Serie		46.0
Total		96.0

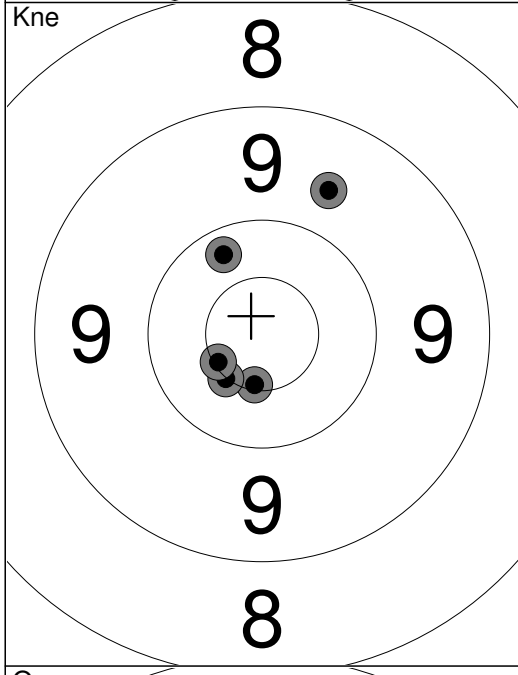

1:	10.3	↖
2:	*10.6	↓
3:	9.6	↗
4:	*10.5	↓
5:	*10.6	↖
Serie		49.0
Total		145.0

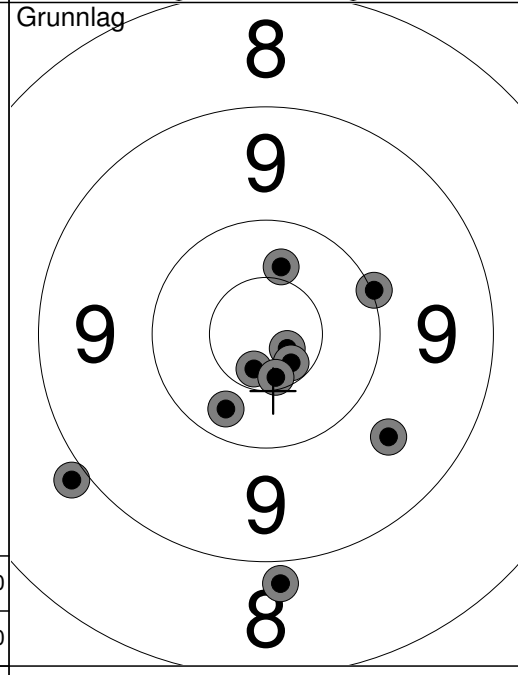

1:	9.6	↘
2:	8.8	↓
3:	8.9	↖
4:	10.3	↓
5:	10.0	↗
6:	*10.7	↓
7:	*10.8	↘
8:	*10.7	↘
9:	10.4	↗
10:	*10.6	↓
Serie		95.0
Total		240.0

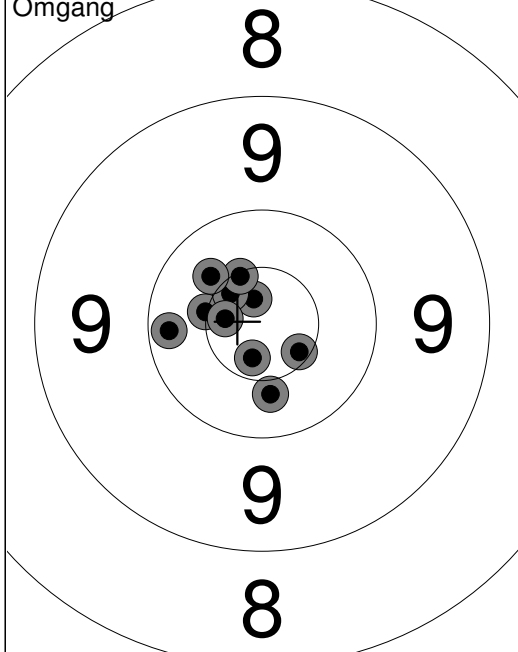

1:	*10.5	←
2:	*10.8	↗
3:	*10.6	↗
4:	*10.7	←
5:	*10.6	↗
6:	10.4	↗
7:	*10.7	↓
8:	*10.6	↓
9:	10.4	↓
10:	10.2	←
Serie		100.0
Total		340.0

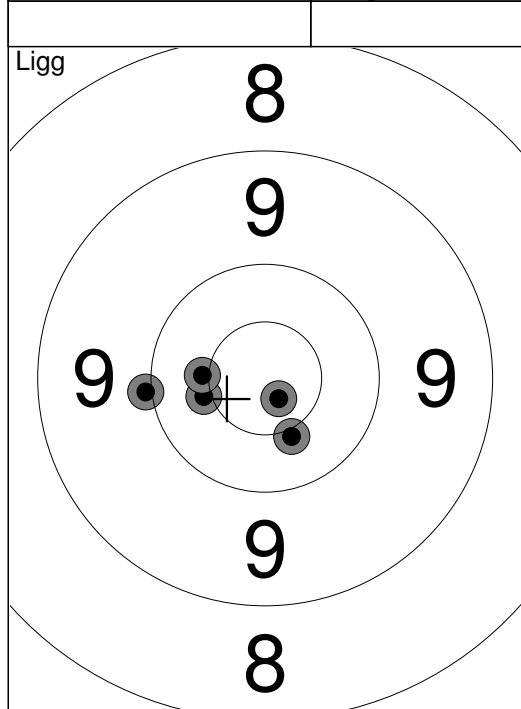

1:	*10.8	↘
2:	10.0	←
3:	*10.5	←
4:	*10.5	←
5:	*10.5	↘
Serie		50.0
Total		50.0

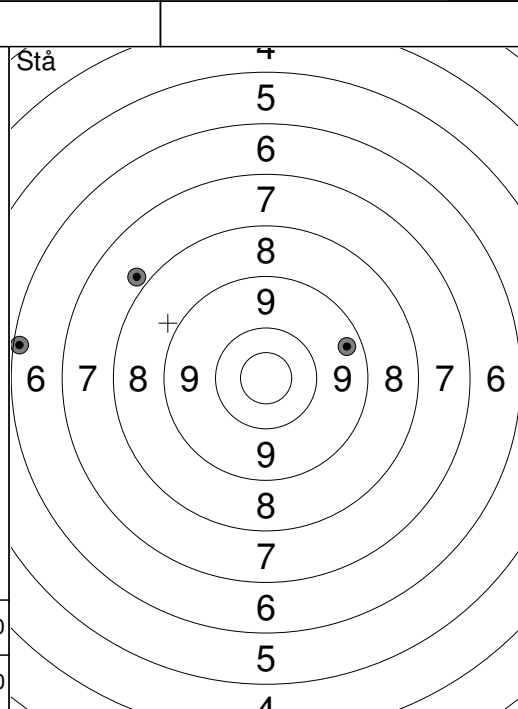

1:	7.8	↖
2:	9.3	↗
3:	6.2	←
Serie		22.0
Total		72.0

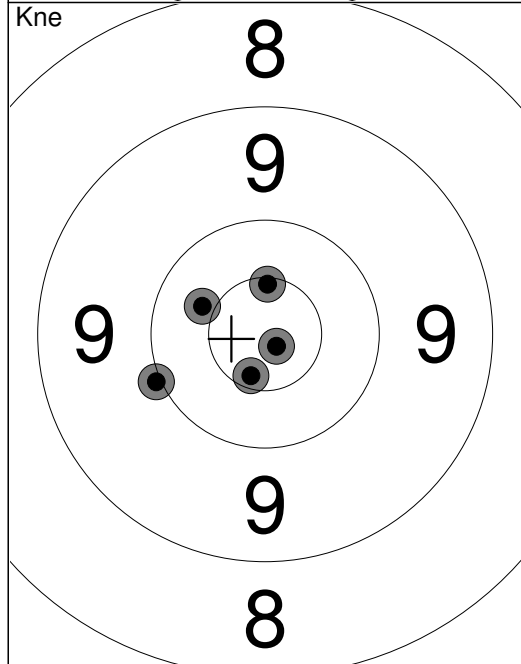

1:	*10.6	↑
2:	10.0	←
3:	*10.6	↘
4:	*10.9	↘
5:	10.4	↖
Serie		50.0
Total		122.0

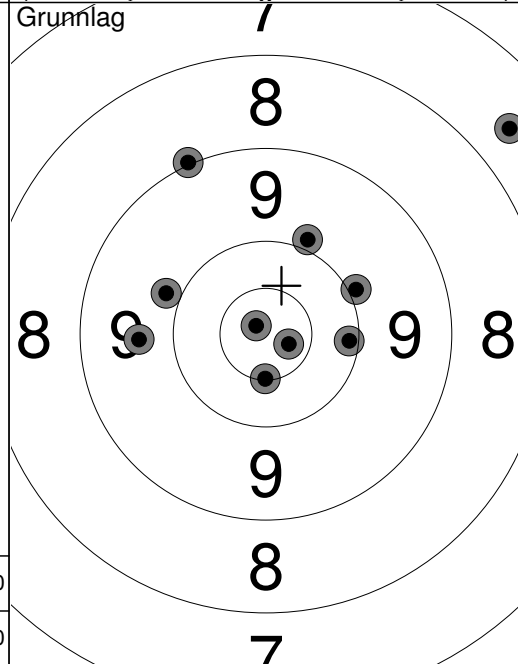

1:	9.9	↖
2:	9.0	↖
3:	7.6	↗
4:	9.7	←
5:	10.1	→
6:	*10.8	↘
7:	10.0	↗
8:	9.9	↖
9:	*10.6	↓
10:	*10.9	↖
Serie		93.0
Total		215.0

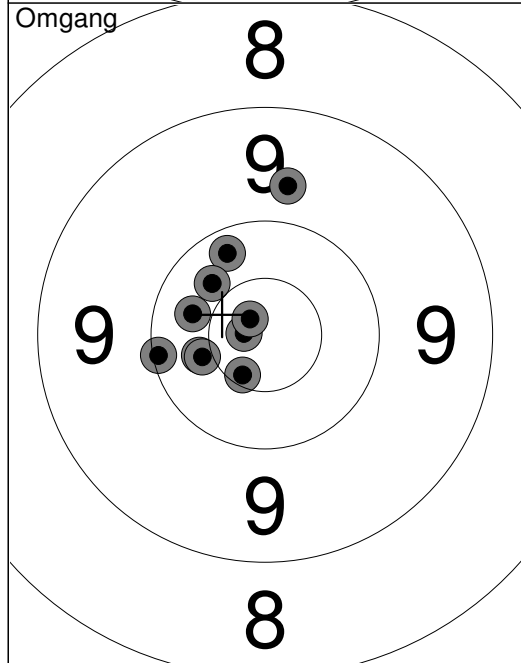

1:	10.1	←
2:	10.2	↖
3:	10.4	←
4:	*10.8	←
5:	*10.6	↘
6:	10.4	↖
7:	9.7	↑
8:	*10.8	↖
9:	10.4	←
10:	10.4	←
Serie		99.0
Total		314.0

<p>Ligg</p>	<p>1: 10.3 ↓</p> <p>2: 10.4 ↖</p> <p>3: 10.3 ↓</p> <p>4: *10.5 ↗</p> <p>5: 10.0 ↓</p>	<p>Stå</p>	<p>1: 10.0 →</p> <p>2: 9.8 ↙</p> <p>3: *10.7 ↖</p> <p>4: 10.3 ↑</p> <p>5: 8.9 ↖</p>								
	<table border="1" style="width:100%; border-collapse: collapse;"> <tr> <td style="text-align: right;">Serie</td> <td style="text-align: right;">50.0</td> </tr> <tr> <td style="text-align: right;">Total</td> <td style="text-align: right;">50.0</td> </tr> </table>	Serie	50.0	Total	50.0		<table border="1" style="width:100%; border-collapse: collapse;"> <tr> <td style="text-align: right;">Serie</td> <td style="text-align: right;">47.0</td> </tr> <tr> <td style="text-align: right;">Total</td> <td style="text-align: right;">97.0</td> </tr> </table>	Serie	47.0	Total	97.0
Serie	50.0										
Total	50.0										
Serie	47.0										
Total	97.0										

<p>Kne</p>	<p>1: 9.7 →</p> <p>2: *10.8 ↖</p> <p>3: 10.3 →</p> <p>4: 10.3 →</p> <p>5: *10.5 ↓</p>	<p>Grunnlag</p>	<p>1: 9.2 ↑</p> <p>2: 9.8 ↗</p> <p>3: 9.7 ↑</p> <p>4: 10.3 ↗</p> <p>5: 10.3 →</p> <p>6: 10.3 ↖</p> <p>7: *10.6 ↓</p> <p>8: 9.7 ↖</p> <p>9: 9.8 ↖</p> <p>10: 10.3 ↑</p>								
	<table border="1" style="width:100%; border-collapse: collapse;"> <tr> <td style="text-align: right;">Serie</td> <td style="text-align: right;">49.0</td> </tr> <tr> <td style="text-align: right;">Total</td> <td style="text-align: right;">146.0</td> </tr> </table>	Serie	49.0	Total	146.0		<table border="1" style="width:100%; border-collapse: collapse;"> <tr> <td style="text-align: right;">Serie</td> <td style="text-align: right;">95.0</td> </tr> <tr> <td style="text-align: right;">Total</td> <td style="text-align: right;">241.0</td> </tr> </table>	Serie	95.0	Total	241.0
Serie	49.0										
Total	146.0										
Serie	95.0										
Total	241.0										

<p>Omgang</p>	<p>1: 9.9 →</p> <p>2: *10.7 ↗</p> <p>3: 9.9 ↗</p> <p>4: 9.5 ↗</p> <p>5: *10.8 ↖</p> <p>6: 9.9 ↗</p> <p>7: 10.4 ↓</p> <p>8: 9.6 ↗</p> <p>9: 10.4 ↓</p> <p>10: 10.0 ←</p>						
	<table border="1" style="width:100%; border-collapse: collapse;"> <tr> <td style="text-align: right;">Serie</td> <td style="text-align: right;">95.0</td> </tr> <tr> <td style="text-align: right;">Total</td> <td style="text-align: right;">336.0</td> </tr> </table>	Serie	95.0	Total	336.0		
Serie	95.0						
Total	336.0						

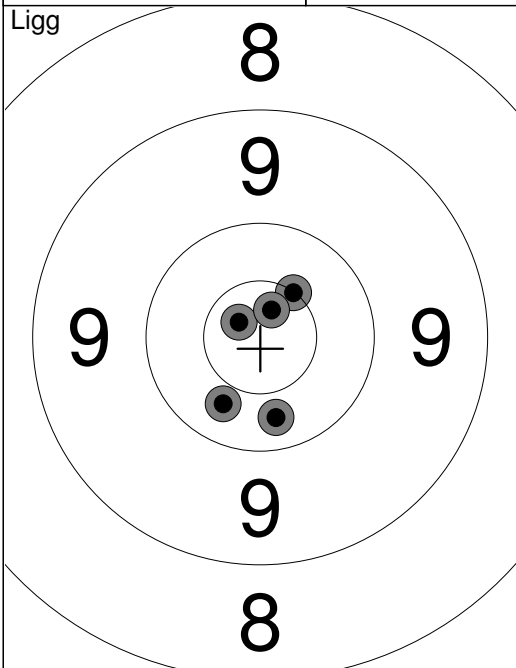

1:	*10.5 ↗
2:	10.4 ↘
3:	*10.8 ↖
4:	10.3 ↘
5:	*10.8 ↗
<hr/>	
Serie	50.0
Total	50.0

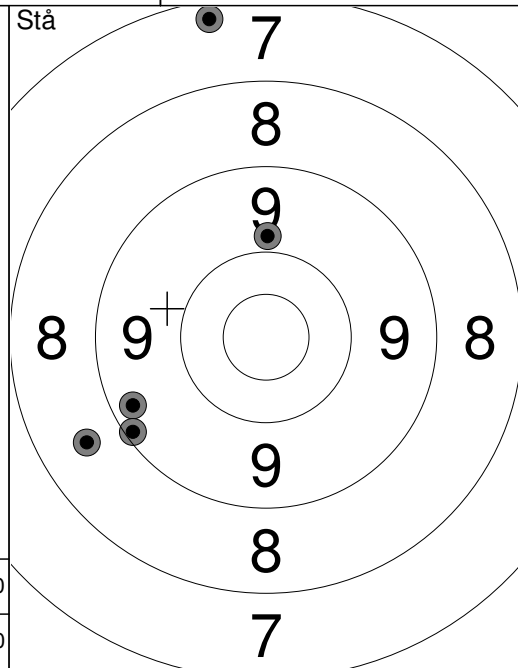

1:	8.6 ↖
2:	9.3 ↖
3:	9.8 ↑
4:	7.2 ↑
5:	9.1 ↘
<hr/>	
Serie	42.0
Total	92.0

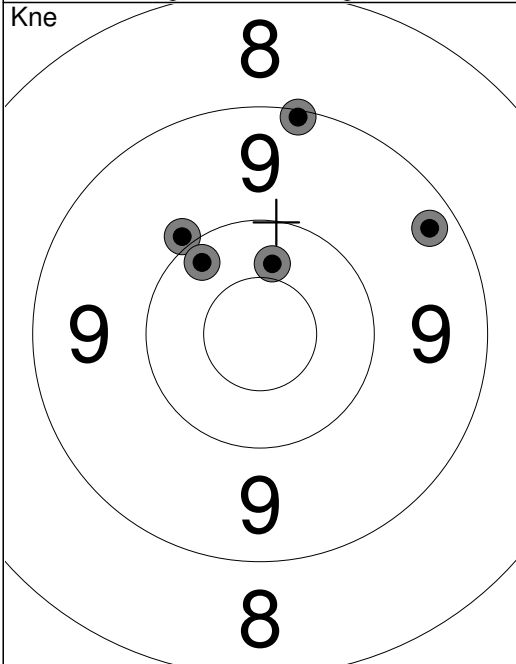

1:	9.9 ↖
2:	10.2 ↖
3:	9.3 ↗
4:	9.1 ↑
5:	10.4 ↑
<hr/>	
Serie	47.0
Total	139.0

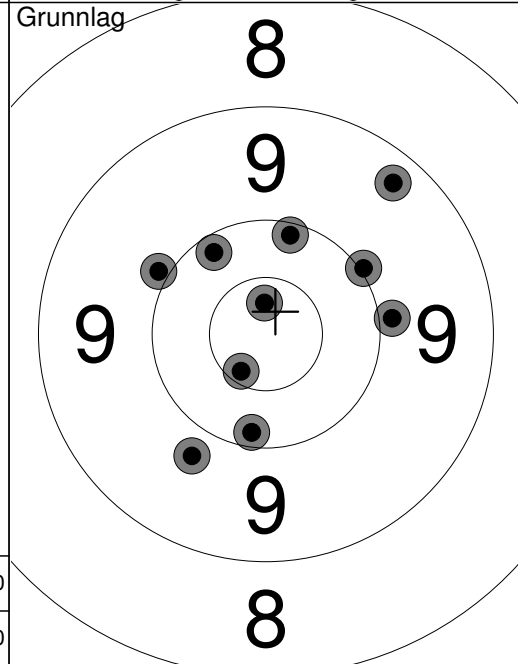

1:	10.1 ↑
2:	10.2 ↓
3:	9.9 →
4:	*10.6 ↘
5:	10.0 ↗
6:	9.8 ↘
7:	10.2 ↖
8:	9.3 ↗
9:	*10.8 ↑
10:	9.9 ↖
<hr/>	
Serie	96.0
Total	235.0

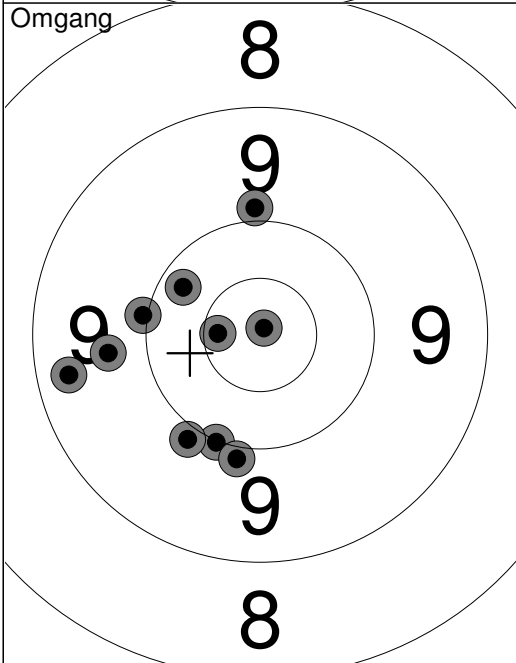

1:	10.0 ↖
2:	*10.9 ↗
3:	9.9 ↑
4:	10.0 ↘
5:	*10.7 ↖
6:	9.9 ↘
7:	9.9 ↘
8:	9.7 ↖
9:	9.3 ↖
10:	10.2 ↖
<hr/>	
Serie	95.0
Total	330.0