

1:	10.4	↑
2:	10.2	↗
3:	10.4	↑
4:	10.3	↑
5:	10.2	↘
Series		50.0
Total		50.0

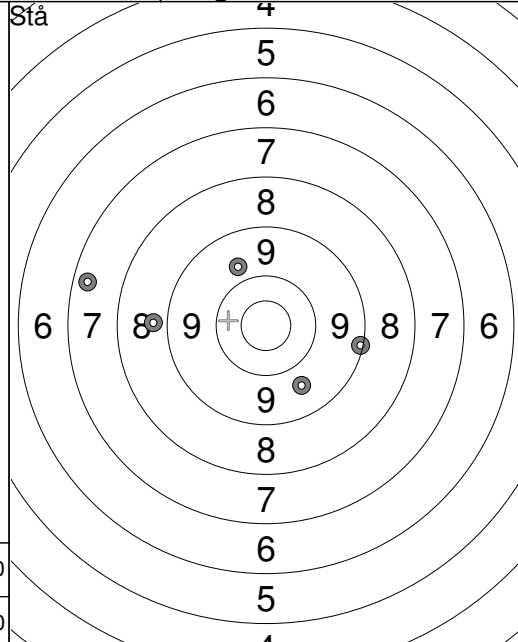

1:	8.8	←
2:	9.6	↘
3:	9.7	↗
4:	9.1	→
5:	7.3	←
Series		42.0
Total		92.0

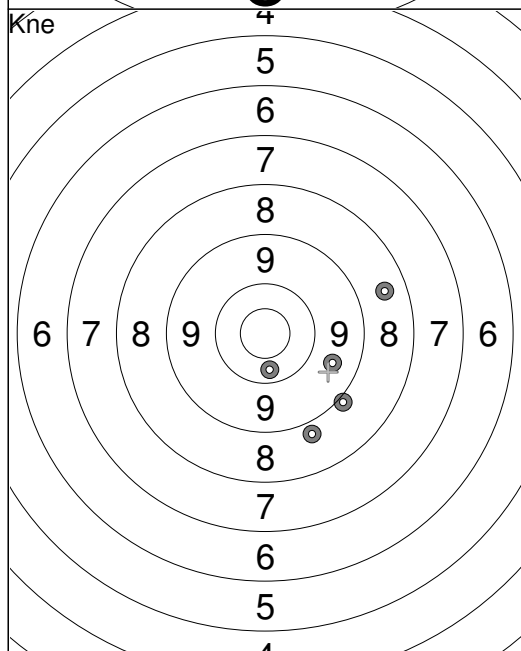

1:	8.5	→
2:	10.3	↘
3:	8.8	↘
4:	9.5	↘
5:	8.9	↘
Series		43.0
Total		135.0

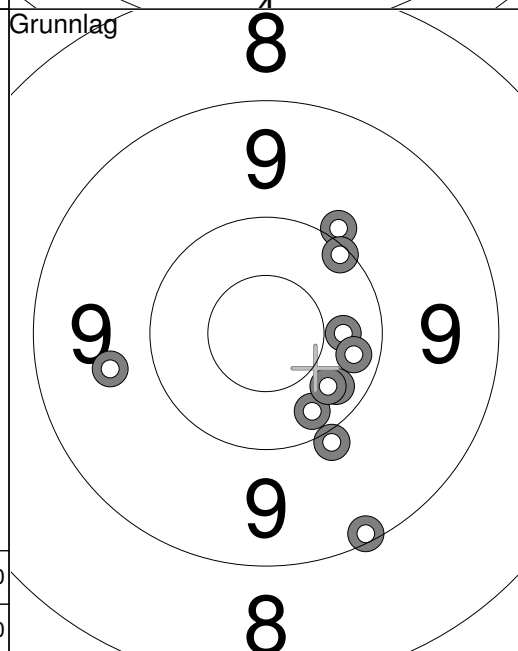

1:	9.1	↘
2:	9.7	←
3:	9.9	↗
4:	10.1	↗
5:	10.3	↘
6:	10.2	↘
7:	10.4	→
8:	10.3	→
9:	9.9	↘
10:	10.3	↘
Series		96.0
Total		231.0

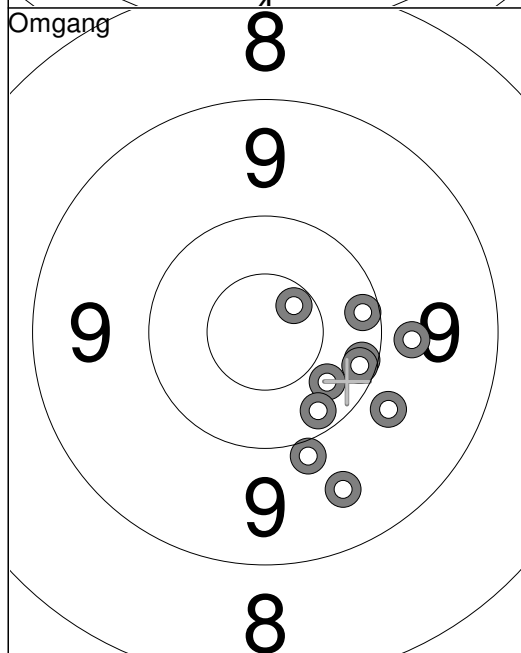

1:	10.2	↘
2:	10.3	↘
3:	10.2	↘
4:	9.8	↘
5:	9.9	↘
6:	10.2	↘
7:	9.8	→
8:	10.2	→
9:	*10.7	↗
10:	9.5	↘
Series		96.0
Total		327.0

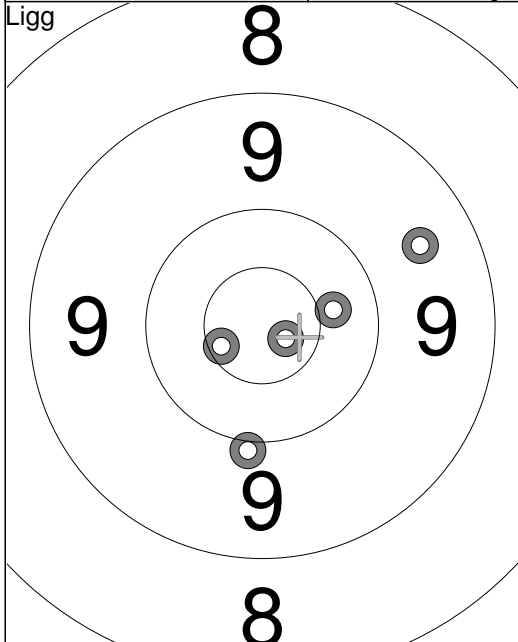

1:	9.5	↗
2:	10.0	↓
3:	*10.8	↘
4:	*10.6	↙
5:	10.4	→
Series		49.0
Total		49.0

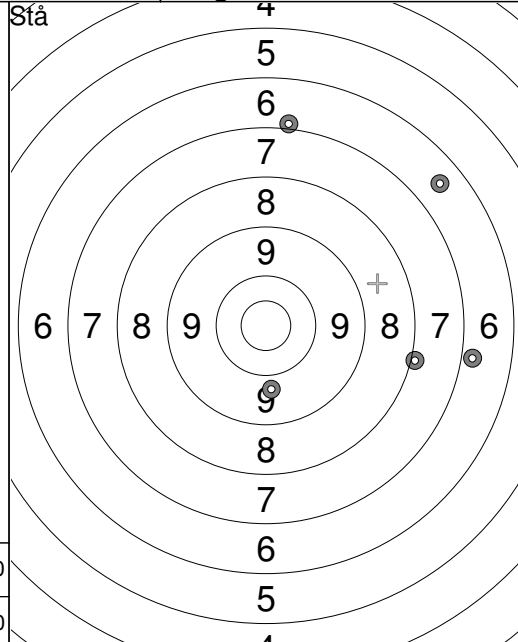

1:	6.5	↗
2:	6.9	↑
3:	6.8	→
4:	9.8	↓
5:	7.9	↘
Series		34.0
Total		83.0

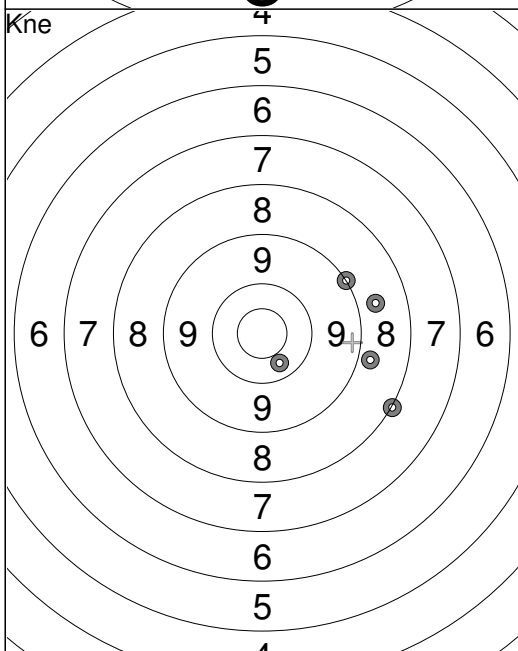

1:	9.0	↗
2:	8.0	↘
3:	10.3	↓
4:	8.7	→
5:	8.8	↘
Series		43.0
Total		126.0

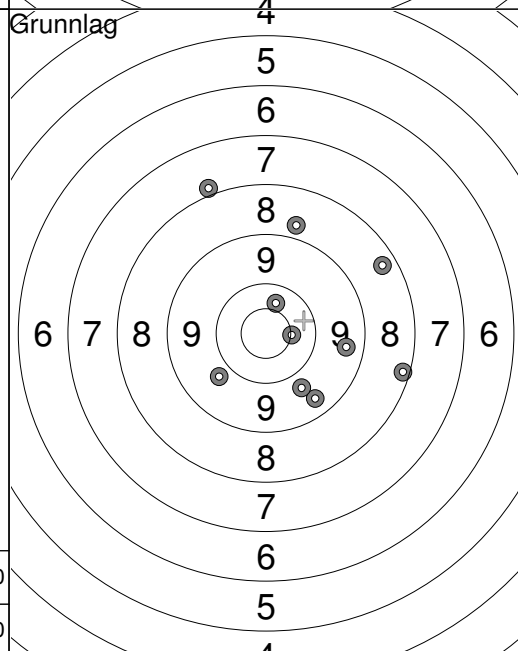

1:	7.9	↖
2:	8.2	→
3:	8.8	↑
4:	9.4	→
5:	*10.5	→
6:	9.7	↙
7:	8.3	↗
8:	10.4	↑
9:	9.4	↓
10:	9.7	↘
Series		87.0
Total		213.0

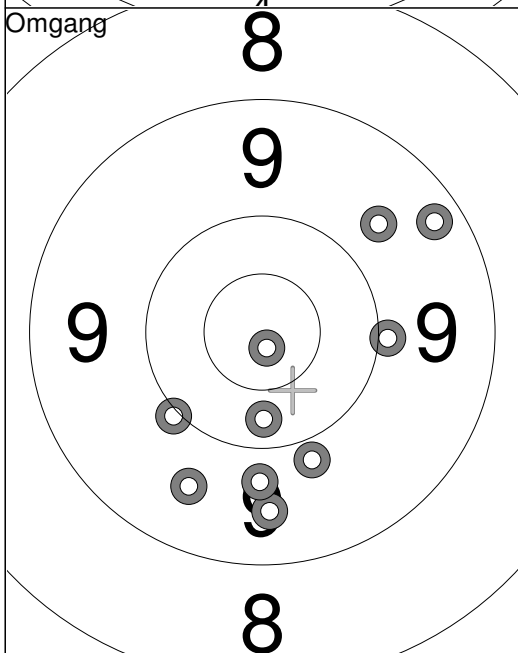

1:	9.7	↗
2:	9.6	↘
3:	9.3	↗
4:	9.5	↓
5:	9.7	↓
6:	10.3	↓
7:	*10.9	↓
8:	10.0	→
9:	9.8	↓
10:	10.0	↙
Series		94.0
Total		307.0

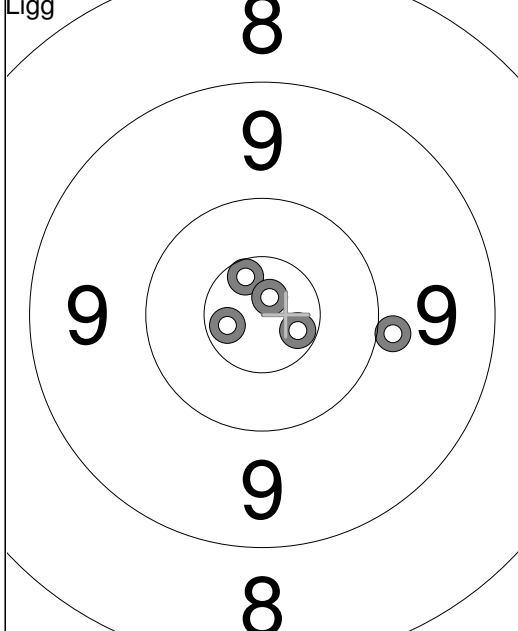

1: *10.7	↑
2: *10.7	←
3: 9.9	→
4: *10.9	↑
5: *10.7	→
<hr/>	
Series	49.0
Total	49.0

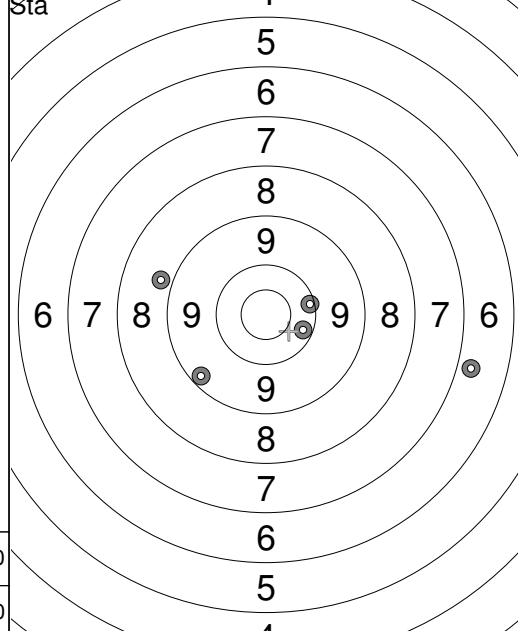

1: 9.2	↙
2: 10.2	→
3: 8.8	←
4: 10.1	→
5: 6.8	→
<hr/>	
Series	43.0
Total	92.0

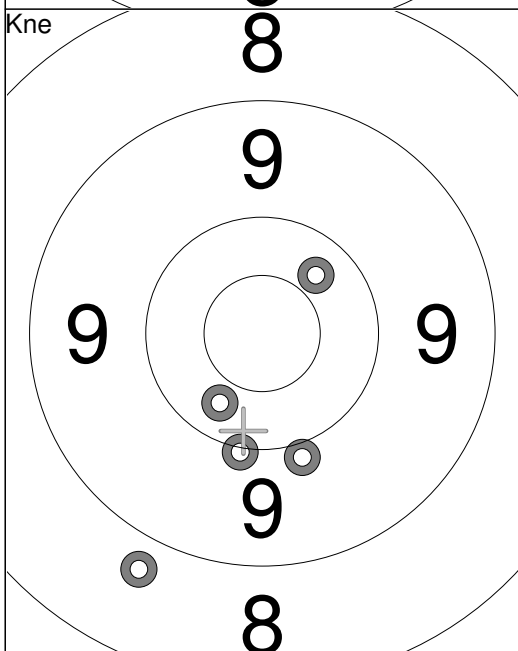

1: 10.3	↙
2: 8.7	↙
3: 9.9	↓
4: 10.4	↗
5: 10.0	↓
<hr/>	
Series	47.0
Total	139.0

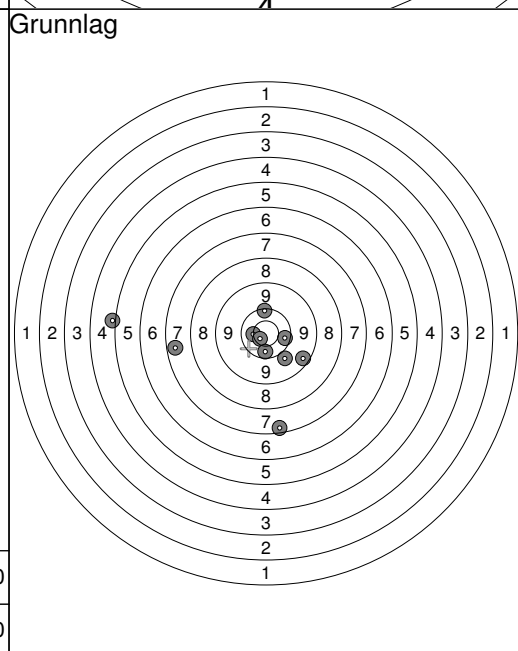

1: 4.9	←
2: 10.1	↑
3: 7.4	←
4: *10.5	←
5: 10.3	→
6: 7.2	↓
7: *10.7	↙
8: 9.8	↓
9: 9.3	↓
10: 10.3	↓
<hr/>	
Series	86.0
Total	225.0

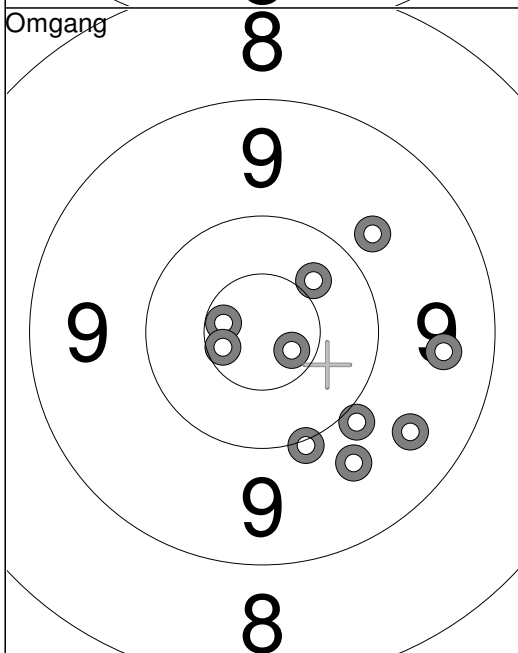

1: *10.7	←
2: 10.4	↗
3: 9.5	→
4: *10.7	↘
5: 9.7	↓
6: *10.7	←
7: 9.8	↗
8: 10.0	↓
9: 9.9	↓
10: 9.5	↓
<hr/>	
Series	95.0
Total	320.0

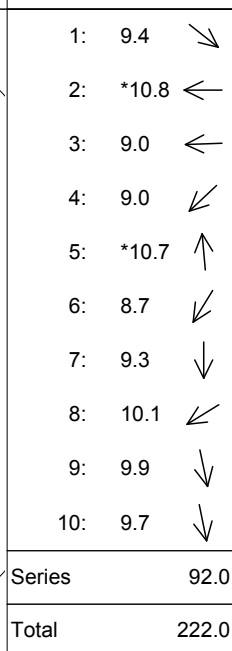
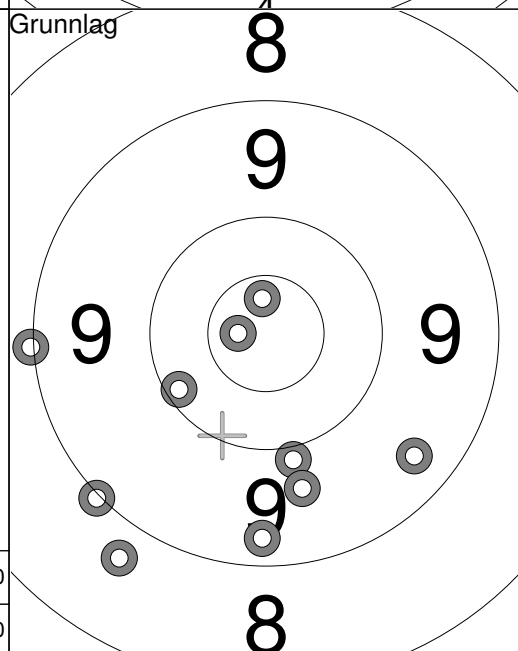
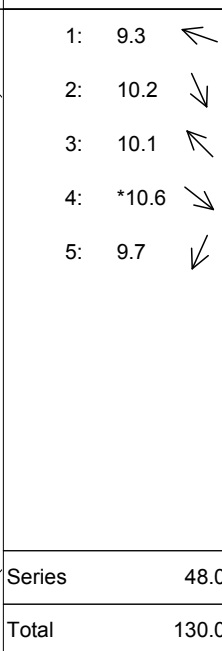
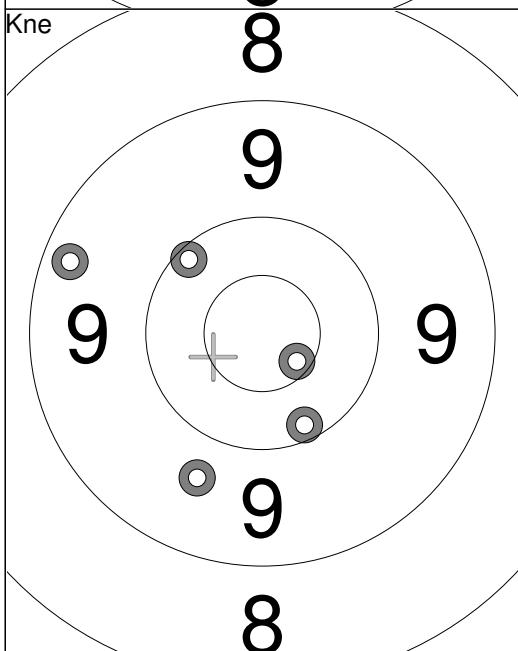
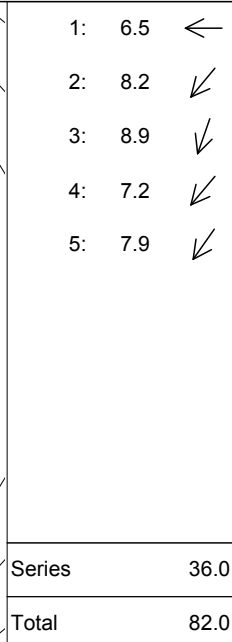
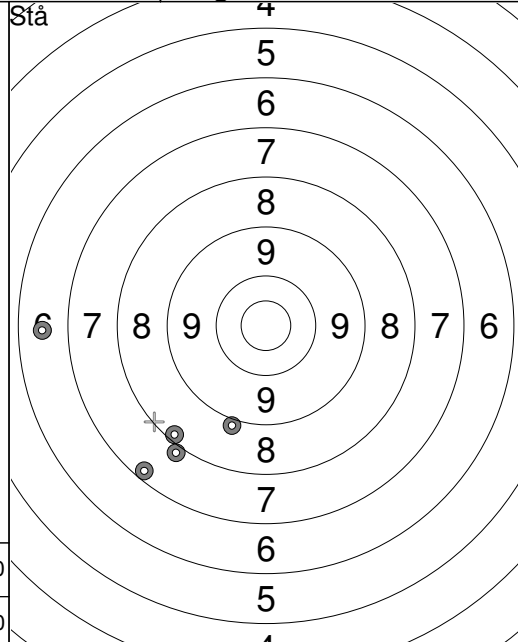
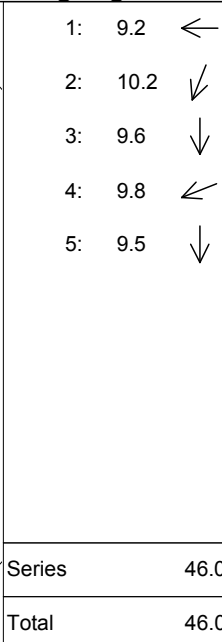
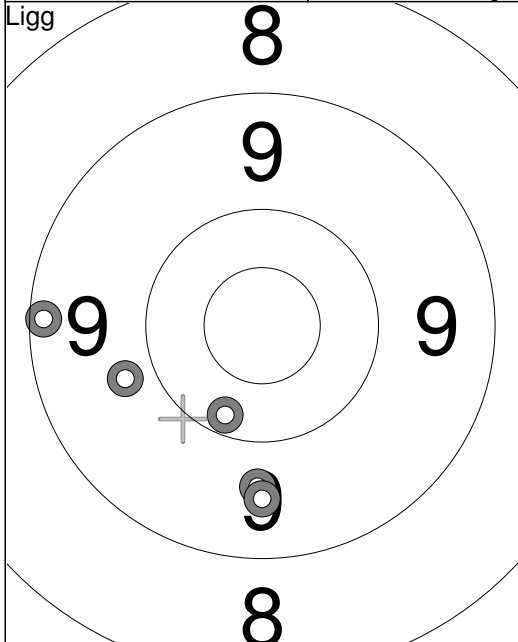

<p>Ligg</p>	<p>1: 9.8 ↗</p> <p>2: *10.9 →</p> <p>3: 10.3 ↖</p> <p>4: 10.3 ↘</p> <p>5: 10.0 ↘</p>	<p>Stå</p>	<p>1: 9.2 ↗</p> <p>2: 9.5 ↑</p> <p>3: 9.1 ←</p> <p>4: 10.2 ←</p> <p>5: 10.2 ↑</p>
Series 49.0		Series 47.0	
Total 49.0		Total 96.0	

<p>Kne</p>	<p>1: 10.0 ↖</p> <p>2: 10.2 ↑</p> <p>3: 9.9 ↑</p> <p>4: 9.5 ←</p> <p>5: 9.9 ←</p>	<p>Grunnlag</p>	<p>1: 10.2 →</p> <p>2: 9.6 ↑</p> <p>3: 9.7 →</p> <p>4: 9.5 ↘</p> <p>5: 9.9 →</p> <p>6: 10.3 →</p> <p>7: 9.4 ↗</p> <p>8: 10.2 ↘</p> <p>9: 9.9 ↘</p> <p>10: 10.1 ↘</p>
Series 47.0		Series 94.0	
Total 143.0		Total 237.0	

<p>Omgang</p>	<p>1: *10.6 ←</p> <p>2: 9.5 ↑</p> <p>3: *10.9 ↘</p> <p>4: 10.0 ↘</p> <p>5: 9.6 ↑</p> <p>6: 9.3 ↘</p> <p>7: 9.9 ↗</p> <p>8: 10.2 ↘</p> <p>9: *10.6 ↘</p> <p>10: 10.3 ↘</p>		
Series 96.0			
Total 333.0			

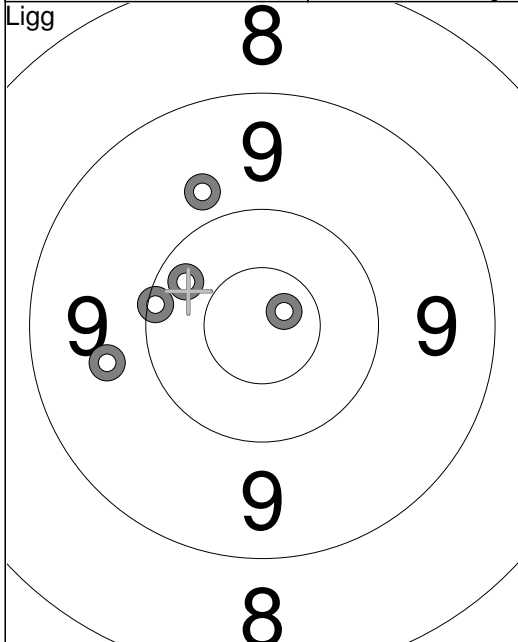

1:	10.1	←
2:	*10.8	↗
3:	9.8	↗
4:	10.3	↖
5:	9.7	←
Series		48.0
Total		48.0

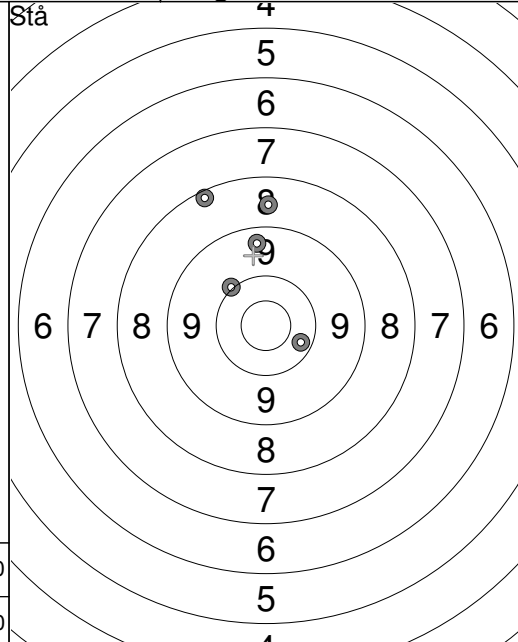

1:	8.2	↖
2:	10.0	↖
3:	10.3	↗
4:	8.6	↑
5:	9.4	↑
Series		45.0
Total		93.0

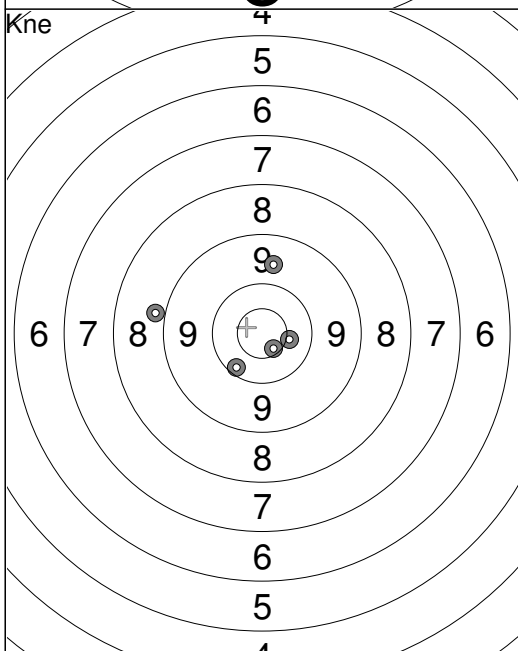

1:	*10.6	↘
2:	*10.5	→
3:	9.6	↑
4:	8.8	←
5:	10.2	↘
Series		47.0
Total		140.0

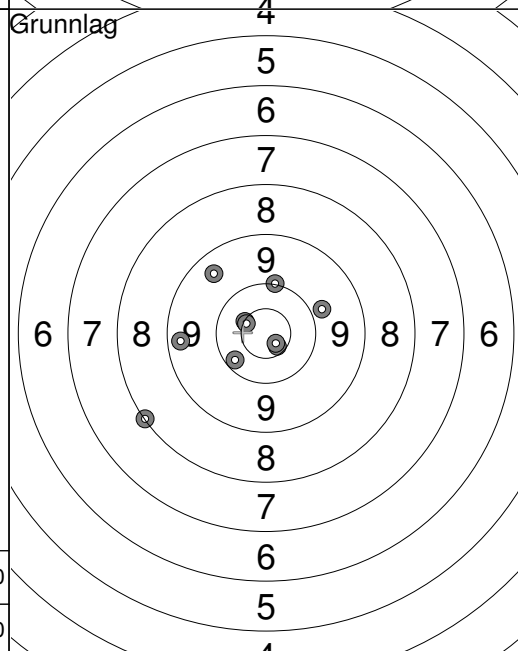

1:	8.0	↖
2:	*10.7	↘
3:	10.2	↖
4:	9.4	↗
5:	9.3	←
6:	*10.5	↗
7:	*10.8	↘
8:	9.8	→
9:	*10.6	↖
10:	10.0	↑
Series		95.0
Total		235.0

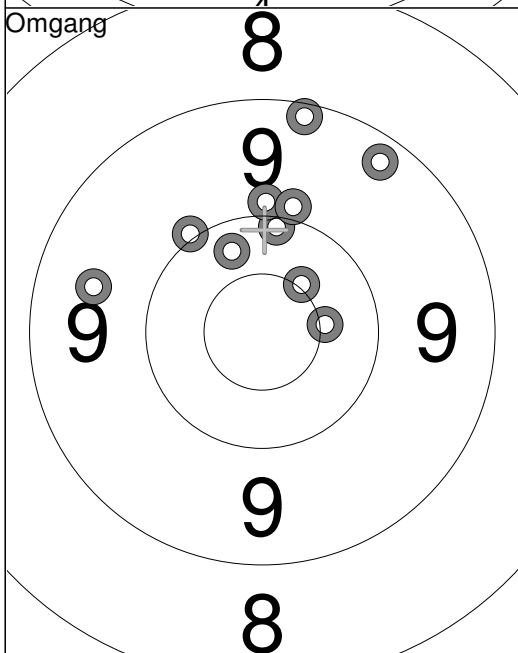

1:	*10.5	→
2:	9.1	↑
3:	10.3	↖
4:	*10.5	↗
5:	9.3	↗
6:	10.0	↖
7:	10.1	↑
8:	9.9	↑
9:	9.5	←
10:	9.9	↑
Series		95.0
Total		330.0

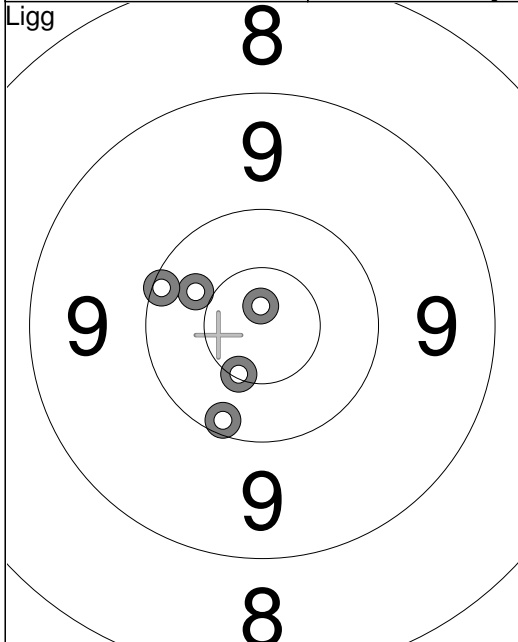

1:	10.4	↖
2:	*10.6	↘
3:	10.1	↘
4:	*10.9	↗
5:	10.1	↖
Series		50.0
Total		50.0

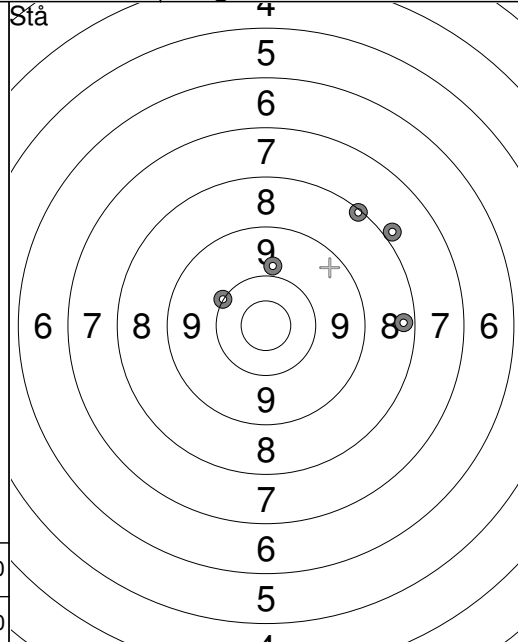

1:	9.8	↗
2:	8.3	→
3:	8.1	↗
4:	7.9	↗
5:	10.0	↖
Series		42.0
Total		92.0

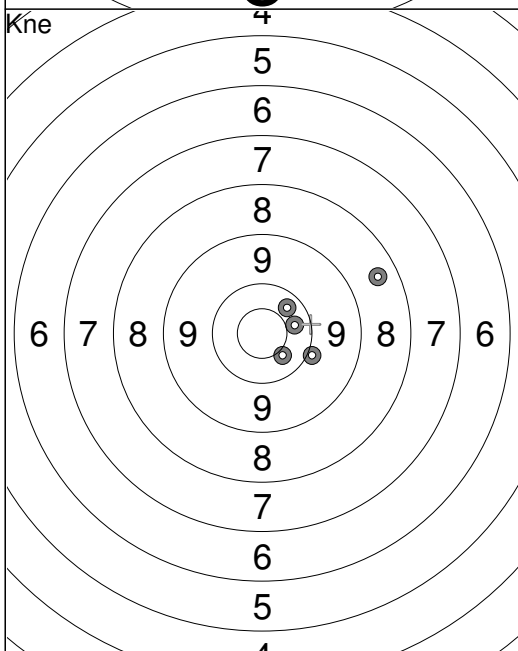

1:	10.3	↗
2:	8.4	→
3:	10.4	↘
4:	10.3	→
5:	9.9	↘
Series		47.0
Total		139.0

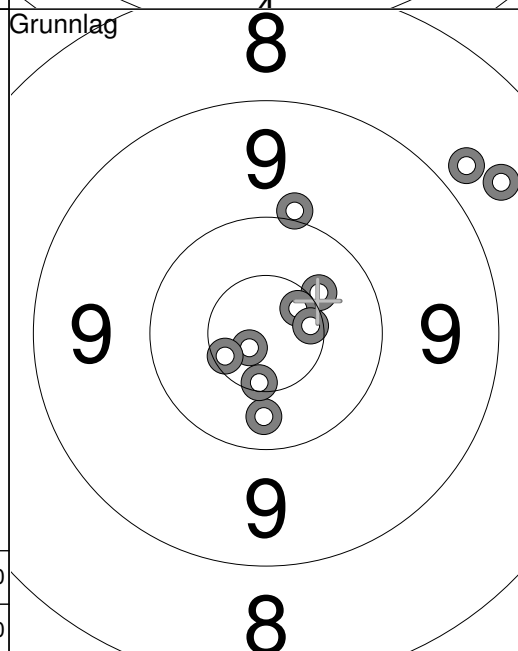

1:	*10.5	↗
2:	8.6	↗
3:	8.8	↗
4:	*10.7	↗
5:	*10.6	→
6:	*10.8	↘
7:	9.9	↗
8:	10.3	↘
9:	*10.6	↘
10:	*10.6	↖
Series		95.0
Total		234.0

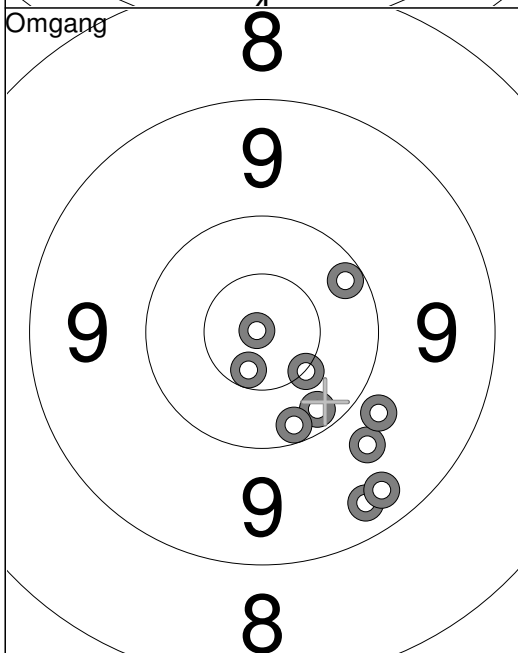

1:	*10.7	↘
2:	10.2	↘
3:	10.2	↘
4:	9.7	↘
5:	9.8	↘
6:	9.3	↘
7:	*10.9	↖
8:	9.3	↘
9:	10.2	↗
10:	*10.5	↘
Series		96.0
Total		330.0

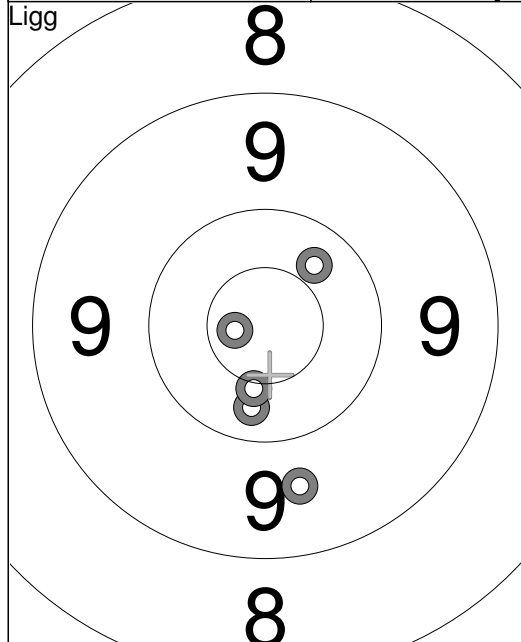

1:	10.4	↗
2:	*10.8	←
3:	10.3	↓
4:	9.6	↓
5:	*10.5	↓
<b>Series</b>		49.0
<b>Total</b>		49.0

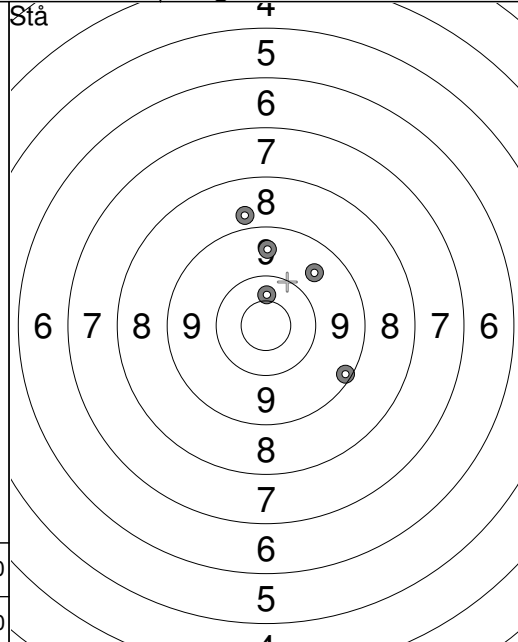

1:	9.2	↘
2:	8.8	↑
3:	10.4	↑
4:	9.5	↑
5:	9.6	↗
<b>Series</b>		45.0
<b>Total</b>		94.0

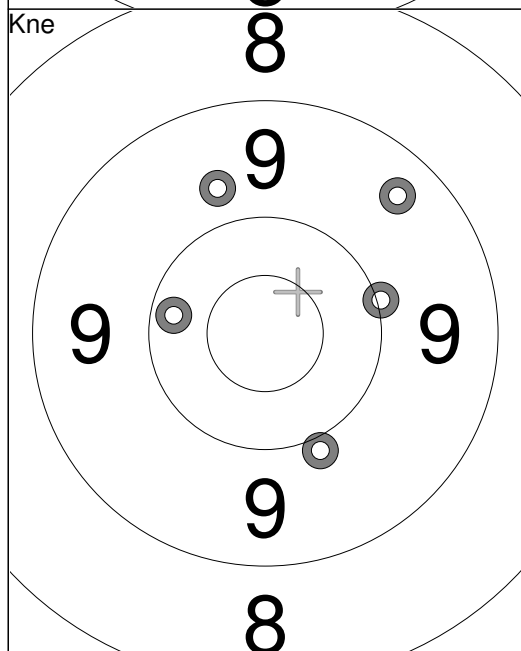

1:	9.7	↖
2:	9.4	↗
3:	9.9	↓
4:	10.2	←
5:	10.0	→
<b>Series</b>		47.0
<b>Total</b>		141.0

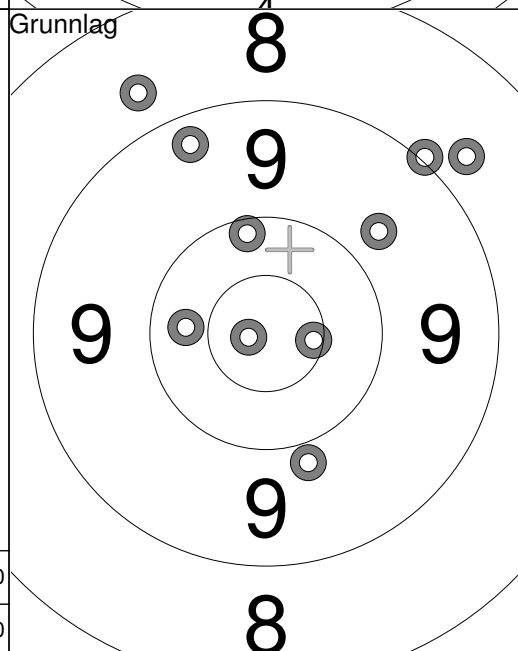

1:	8.7	↖
2:	9.7	↗
3:	9.0	↗
4:	8.7	↗
5:	*10.6	→
6:	10.3	←
7:	10.2	↑
8:	*10.9	←
9:	9.3	↑
10:	9.9	↓
<b>Series</b>		92.0
<b>Total</b>		233.0

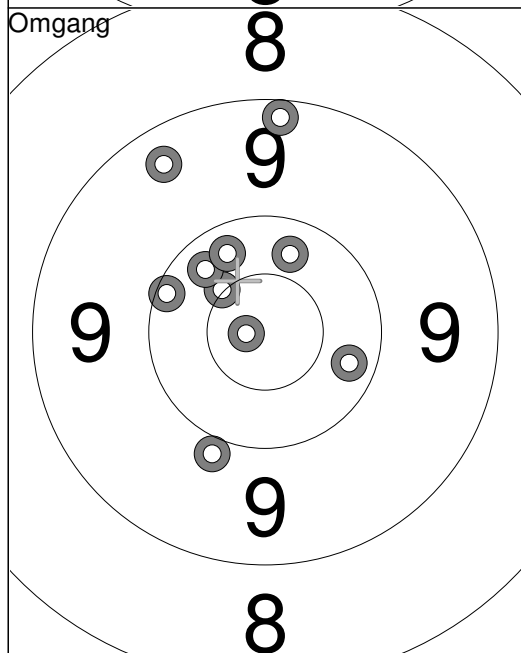

1:	9.2	↑
2:	*10.9	←
3:	9.3	↗
4:	*10.5	↗
5:	10.3	→
6:	10.1	←
7:	10.3	↑
8:	9.9	↓
9:	10.3	↗
10:	10.3	↗
<b>Series</b>		97.0
<b>Total</b>		330.0

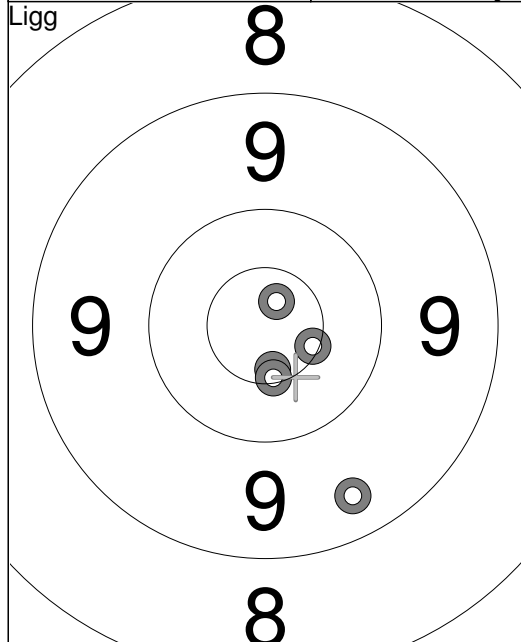

1:	*10.6	↓
2:	*10.8	↗
3:	9.4	↓
4:	*10.6	→
5:	*10.6	↓
<b>Series</b>		<b>49.0</b>
<b>Total</b>		<b>49.0</b>

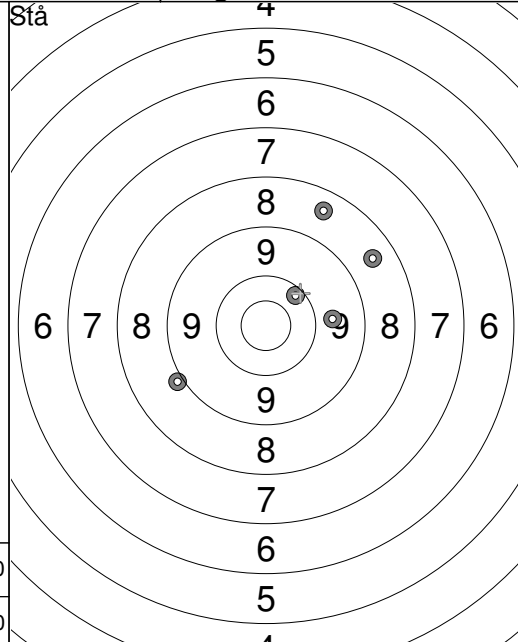

1:	8.4	↗
2:	9.7	→
3:	8.5	↗
4:	10.2	↗
5:	8.9	↙
<b>Series</b>		<b>43.0</b>
<b>Total</b>		<b>92.0</b>

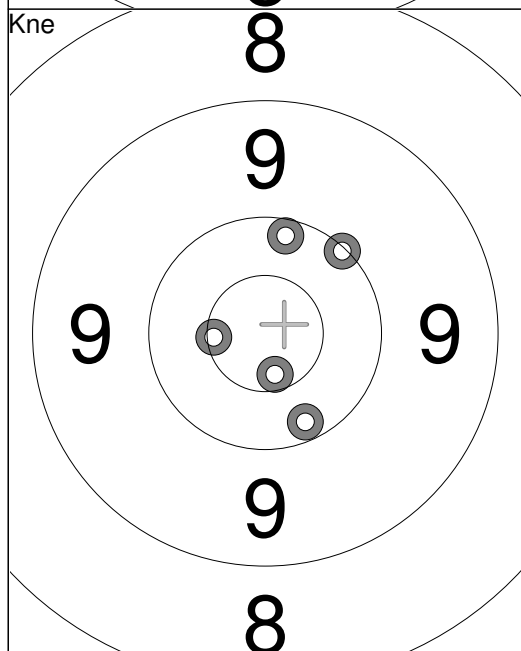

1:	*10.7	↓
2:	10.2	↓
3:	*10.6	←
4:	10.2	↗
5:	10.1	↗
<b>Series</b>		<b>50.0</b>
<b>Total</b>		<b>142.0</b>

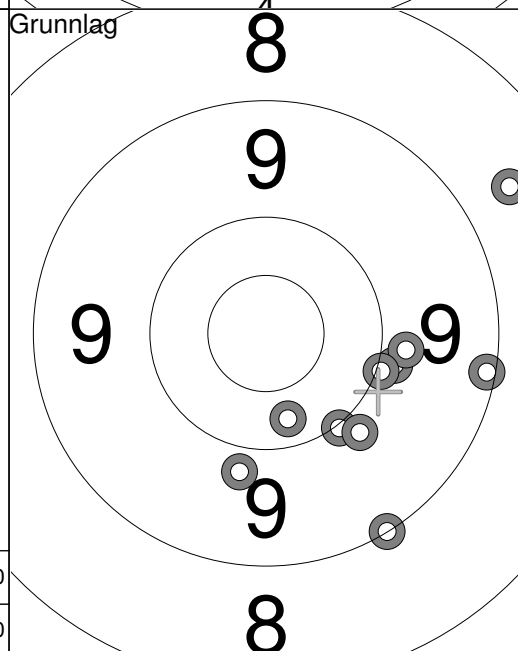

1:	9.0	↓
2:	8.6	↗
3:	10.0	↓
4:	9.9	→
5:	9.1	→
6:	9.9	↓
7:	9.8	→
8:	9.8	↓
9:	10.0	→
10:	10.3	↓
<b>Series</b>		<b>92.0</b>
<b>Total</b>		<b>234.0</b>

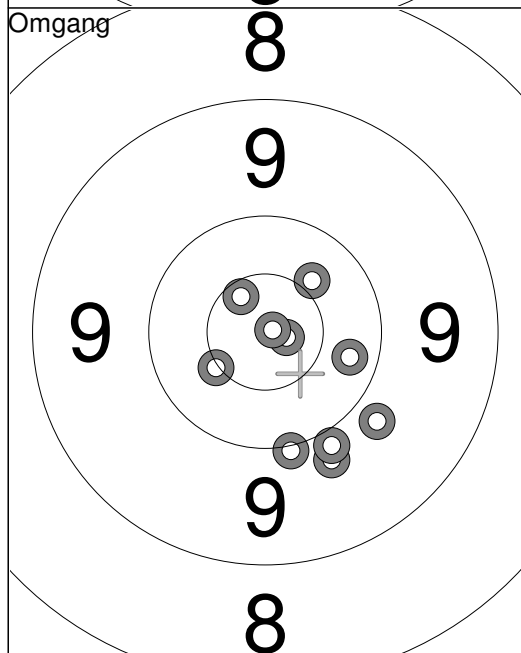

1:	10.4	↗
2:	10.0	↓
3:	9.8	↓
4:	*10.5	↙
5:	10.3	→
6:	*10.7	↗
7:	9.9	↓
8:	*10.8	→
9:	*10.9	→
10:	9.8	↓
<b>Series</b>		<b>97.0</b>
<b>Total</b>		<b>331.0</b>

<p><b>Ligg</b></p>	<p><b>Stå</b></p>	<p>1: 7.8 ↗</p> <p>2: 9.2 ↙</p> <p>3: 9.9 ↑</p> <p>4: *10.8 ←</p> <p>5: 10.3 ↘</p>
Series 48.0	Series 45.0	
Total 48.0	Total 93.0	

<p><b>Kne</b></p>	<p><b>Grunnlag</b></p>	<p>1: 9.3 ↗</p> <p>2: 9.4 ↙</p> <p>3: 10.1 ↘</p> <p>4: 9.7 ←</p> <p>5: 10.4 ↘</p> <p>6: 10.1 ↘</p> <p>7: 9.6 ↑</p> <p>8: 9.9 ↙</p> <p>9: 9.5 ↘</p>
Series 48.0	Series 84.0	
Total 141.0	Total 225.0	

<p><b>Omgang</b></p>	<p>1: *10.6 ↗</p> <p>2: 9.1 ↙</p> <p>3: 9.8 ←</p> <p>4: 10.4 ←</p> <p>5: *10.6 ←</p> <p>6: 9.4 ↑</p> <p>7: *10.5 ↑</p> <p>8: 10.0 ↙</p> <p>9: 9.7 ↗</p> <p>10: *10.5 ↗</p>	
Series 96.0		
Total 321.0		

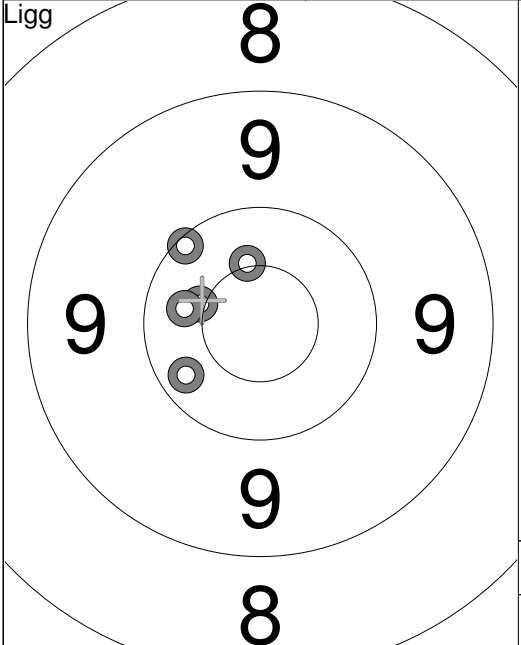
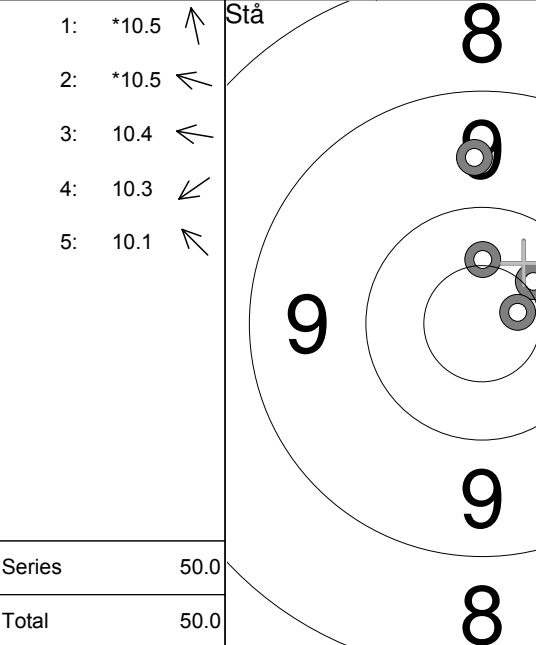
<p>Ligg</p> 	<p>Stå</p> 	<table style="width:100%; border-collapse: collapse;"> <tr><td>1: *10.5</td><td style="text-align: right;">↑</td></tr> <tr><td>2: *10.5</td><td style="text-align: right;">←</td></tr> <tr><td>3: 10.4</td><td style="text-align: right;">←</td></tr> <tr><td>4: 10.3</td><td style="text-align: right;">↙</td></tr> <tr><td>5: 10.1</td><td style="text-align: right;">↖</td></tr> <tr><td colspan="2"><hr/></td></tr> <tr><td>Series</td><td style="text-align: right;">50.0</td></tr> <tr><td colspan="2"><hr/></td></tr> <tr><td>Total</td><td style="text-align: right;">50.0</td></tr> </table>	1: *10.5	↑	2: *10.5	←	3: 10.4	←	4: 10.3	↙	5: 10.1	↖	<hr/>		Series	50.0	<hr/>		Total	50.0
1: *10.5	↑																			
2: *10.5	←																			
3: 10.4	←																			
4: 10.3	↙																			
5: 10.1	↖																			
<hr/>																				
Series	50.0																			
<hr/>																				
Total	50.0																			

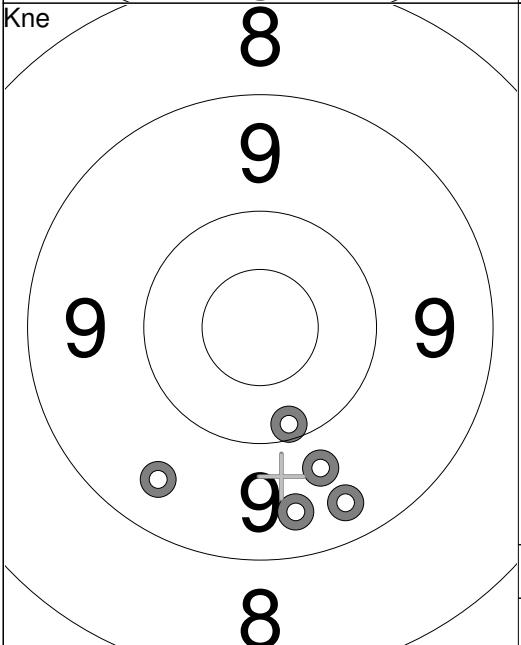
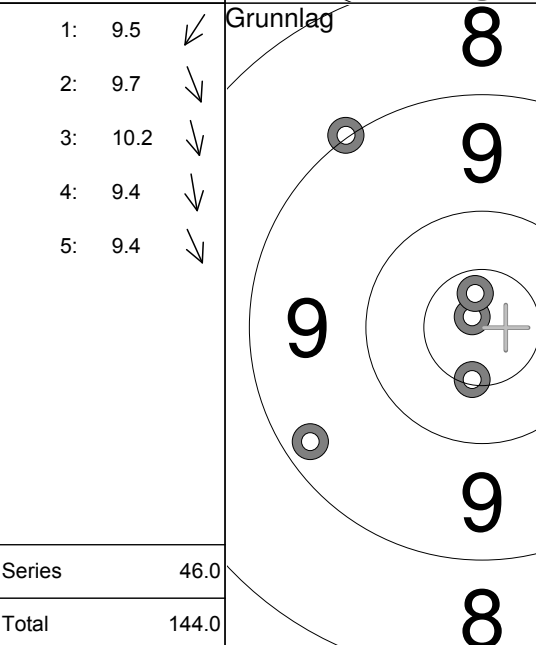
<p>Kne</p> 	<p>Grunnlag</p> 	<table style="width:100%; border-collapse: collapse;"> <tr><td>1: 9.5</td><td style="text-align: right;">↙</td></tr> <tr><td>2: 9.7</td><td style="text-align: right;">↘</td></tr> <tr><td>3: 10.2</td><td style="text-align: right;">↘</td></tr> <tr><td>4: 9.4</td><td style="text-align: right;">↘</td></tr> <tr><td>5: 9.4</td><td style="text-align: right;">↘</td></tr> <tr><td colspan="2"><hr/></td></tr> <tr><td>Series</td><td style="text-align: right;">46.0</td></tr> <tr><td colspan="2"><hr/></td></tr> <tr><td>Total</td><td style="text-align: right;">144.0</td></tr> </table>	1: 9.5	↙	2: 9.7	↘	3: 10.2	↘	4: 9.4	↘	5: 9.4	↘	<hr/>		Series	46.0	<hr/>		Total	144.0
1: 9.5	↙																			
2: 9.7	↘																			
3: 10.2	↘																			
4: 9.4	↘																			
5: 9.4	↘																			
<hr/>																				
Series	46.0																			
<hr/>																				
Total	144.0																			

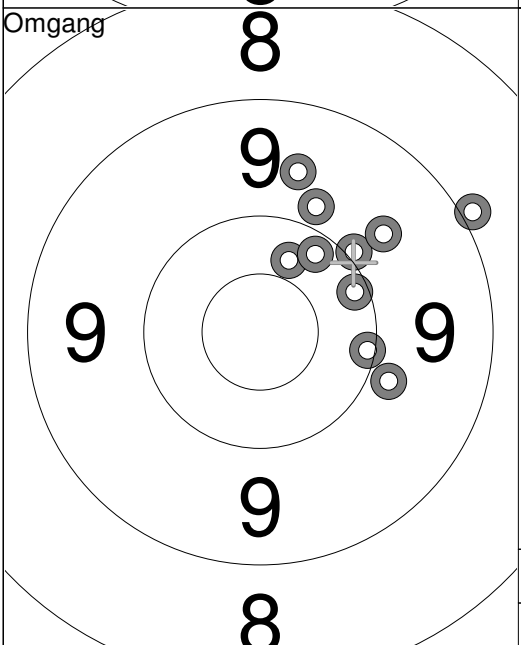
<p>Omgang</p> 		<table style="width:100%; border-collapse: collapse;"> <tr><td>1: 9.6</td><td style="text-align: right;">↑</td></tr> <tr><td>2: 9.9</td><td style="text-align: right;">↑</td></tr> <tr><td>3: 10.0</td><td style="text-align: right;">↗</td></tr> <tr><td>4: 10.1</td><td style="text-align: right;">→</td></tr> <tr><td>5: 10.4</td><td style="text-align: right;">↑</td></tr> <tr><td>6: 10.2</td><td style="text-align: right;">↗</td></tr> <tr><td>7: 8.9</td><td style="text-align: right;">↗</td></tr> <tr><td>8: 10.1</td><td style="text-align: right;">→</td></tr> <tr><td>9: 9.7</td><td style="text-align: right;">↗</td></tr> <tr><td>10: 9.8</td><td style="text-align: right;">→</td></tr> <tr><td colspan="2"><hr/></td></tr> <tr><td>Series</td><td style="text-align: right;">94.0</td></tr> <tr><td colspan="2"><hr/></td></tr> <tr><td>Total</td><td style="text-align: right;">334.0</td></tr> </table>	1: 9.6	↑	2: 9.9	↑	3: 10.0	↗	4: 10.1	→	5: 10.4	↑	6: 10.2	↗	7: 8.9	↗	8: 10.1	→	9: 9.7	↗	10: 9.8	→	<hr/>		Series	94.0	<hr/>		Total	334.0
1: 9.6	↑																													
2: 9.9	↑																													
3: 10.0	↗																													
4: 10.1	→																													
5: 10.4	↑																													
6: 10.2	↗																													
7: 8.9	↗																													
8: 10.1	→																													
9: 9.7	↗																													
10: 9.8	→																													
<hr/>																														
Series	94.0																													
<hr/>																														
Total	334.0																													

Relay <b>2</b>	Lane <b>7</b>	<b>Øyvind Heer</b>
-------------------	------------------	--------------------

200m	Trøgstad	2
------	----------	---

25.04.2011	Klassemedaljer 1. gang	Trøgstad SKL
------------	------------------------	--------------

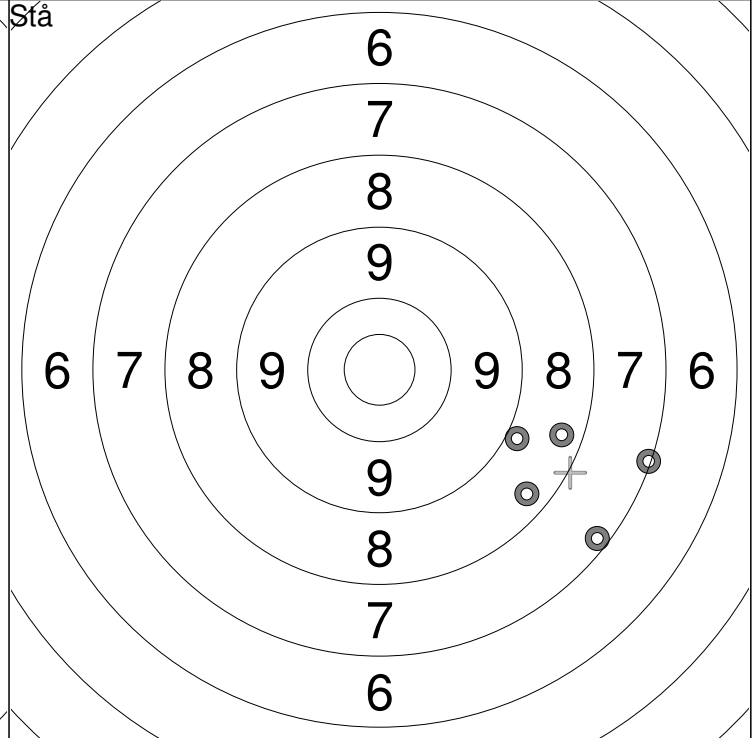
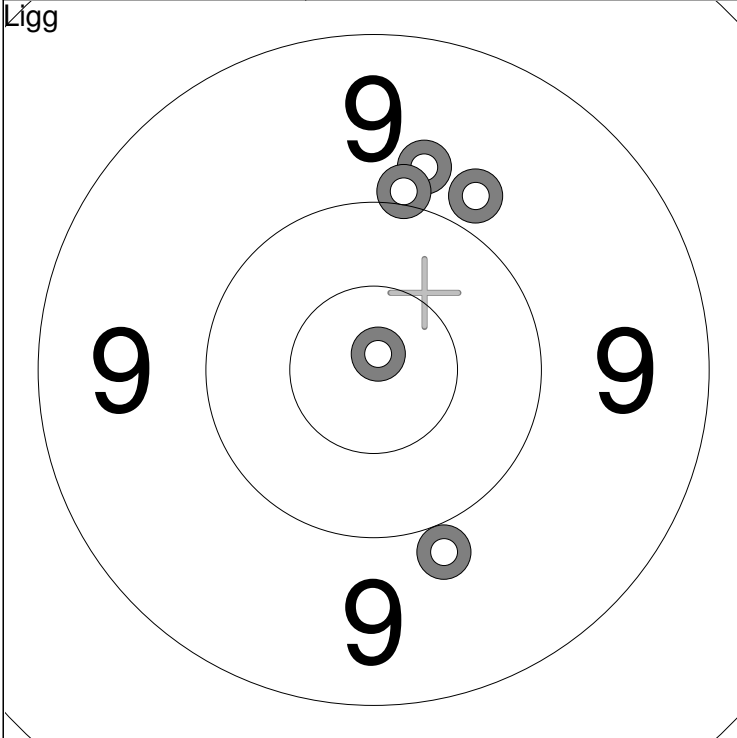

1:	9.8	↑
2:	10.0	↑
3:	9.8	↗
4:	*10.9	↑
5:	9.9	↓

Series	47.0
Total	47.0

1:	8.3	↘
2:	8.3	↘
3:	7.1	↘
4:	8.9	↘
5:	7.2	↘

Series	38.0
Total	85.0

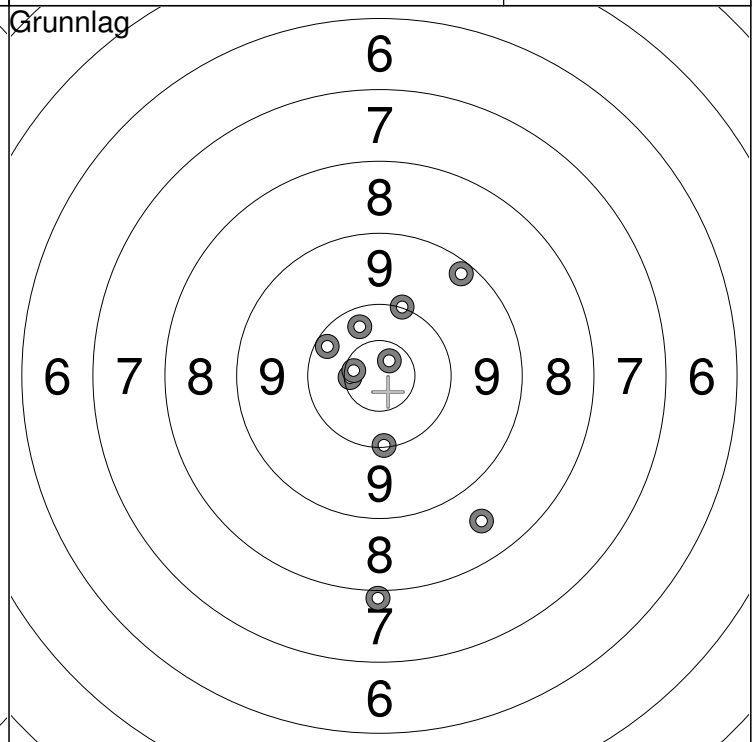
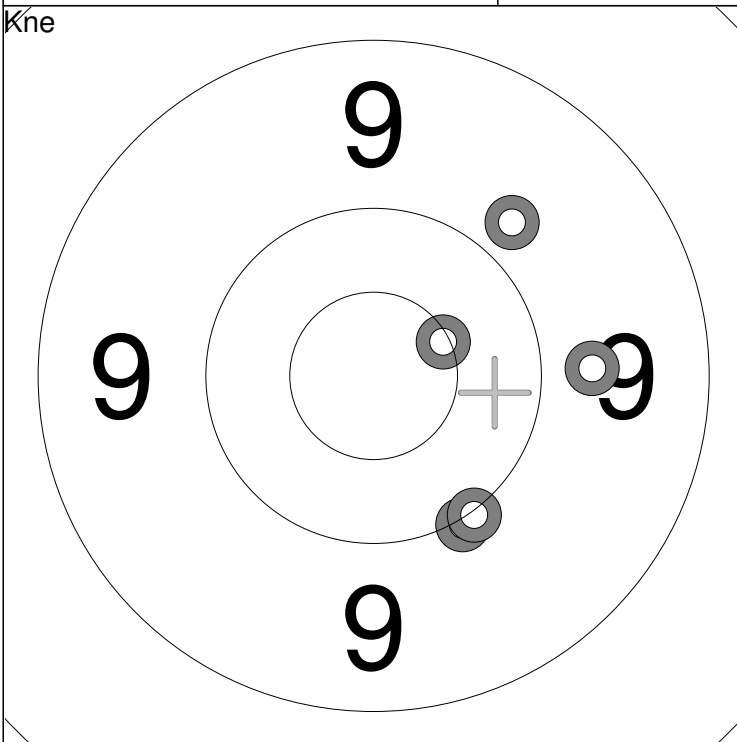

1:	*10.6	↗
2:	10.0	↘
3:	9.8	↗
4:	9.7	→
5:	10.0	↓

Series	48.0
Total	133.0

1:	7.9	↓
2:	8.6	↘
3:	10.3	↗
4:	10.2	↖
5:	*10.6	←

6:	9.2	↗
7:	*10.8	↗
8:	10.1	↓
9:	10.0	↑
10:	*10.7	←

Series	94.0
Total	227.0

Trøgstad Sparebank